

Operation

Engine

Models:

**KG6208 Naturally Aspirated
KG6208TA Turbocharged
Propane, Liquefied Petroleum Gas (LPG)
Natural Gas (NG) Fueled**

KOHLER®

TP-7095 1/19d

▲ WARNING: This product can expose you to chemicals, including carbon monoxide and benzene, which are known to the State of California to cause cancer and birth defects or other reproductive harm. For more information go to www.P65warnings.ca.gov

Product Identification Information

Product identification numbers determine service parts. Record the product identification numbers in the spaces below immediately after unpacking the products so that the numbers are readily available for future reference.

Engine Identification

Record the product identification information from the engine nameplate.

Model Designation: _____

Serial Number: _____

Purchase Date

Upon purchase of your Kohler equipment, record the purchase date for reference when communicating with your authorized Kohler distributor/dealer.

Table of Contents

Safety Precautions and Instructions	5
Introduction	11
Service Assistance	12
Section 1. Components and Maintenance Locations	13
1.1 Naturally Aspirated Engine Side Views	13
1.2 Naturally Aspirated Engine Top and Rear Views	14
1.3 Turbocharged Engine Side Views	15
1.4 Turbocharged Engine Top and Rear Views	16
Section 2. Operation	17
2.1 Introduction	19
2.2 Fuel System	19
2.2.1 Components.....	19
2.2.2 Fuel Specifications.....	26
2.2.3 Before Starting.....	27
2.2.4 Starting.....	28
2.2.5 Cold Weather Starting.....	29
2.2.6 Monitoring Engine Operation	30
2.2.7 Stopping.....	30
Section 3. Maintenance	31
3.1 Introduction	31
3.2 Safety Precautions and Instructions	31
3.3 Fluid Specifications	33
3.3.1 Oil Recommendations.....	33
3.3.2 Coolant Recommendations.....	33
3.4 Periodic Maintenance Schedule	34
3.5 Engine	35
3.5.1 Check Engine Oil	35
3.5.2 Change Engine Oil and Oil Filter.....	36
3.5.3 Check and Clean the Air Filter	39
3.5.4 Replace the Air Filter	39
3.5.5 Check, Adjust and Replace the Spark Plugs.....	39
3.5.6 Ignition Timing.....	41
3.6 Electrical System.....	42
3.6.1 Check Battery and Connections.....	42
3.6.2 Check and Adjust the Drive Belt	43
3.6.3 Replace the Drive Belt	45
3.6.4 Check Wiring and Electrical Connections	46
3.7 Cooling System	47
3.7.1 Check Coolant Level and Condition	48
3.7.2 Check Hoses and Clamps.....	48
3.7.3 Draining and Replacing the Coolant	48
3.8 Fuel System	49
3.8.1 Check Fuel Supply Pipe and Connections	49
3.8.2 Check Fuel Level (LPG only)	49
Section 4. Troubleshooting	51
4.1 Introduction	51
4.2 Troubleshooting	51

Section 5.	Storage.....	53
5.1	Preparation.....	53
5.2	Short-Term Storage (Less than 30 Days).....	53
5.3	Long-Term Storage (More than 30 Days).....	54
5.4	Maintenance while in Storage	54
5.5	Removal from Storage	54
Section 6.	Specifications.....	55
6.1	Engine Specifications	55
6.2	Main Components Specifications	56
6.3	Adjustment Specifications	56
6.4	Torque Specifications.....	56
6.5	Standard Torque Specifications	57

Safety Precautions and Instructions

Read and follow all safety precautions and instructions. SAVE THESE INSTRUCTIONS.

This manual has several types of safety precautions and instructions: Danger, Warning, Caution, and Notice.



Danger indicates the presence of a hazard that **will cause severe personal injury, death, or substantial property damage.**



Warning indicates the presence of a hazard that **can cause severe personal injury, death, or substantial property damage.**



Caution indicates the presence of a hazard that **will or can cause minor personal injury or property damage.**



NOTICE

Notice communicates installation, operation, or maintenance information that is safety related but not hazard related.

Note:



A Note is used to inform you of important installation, operation, or maintenance information.

Accidental Starting

	Accidental starting. Can cause severe injury or death.
	Disconnect the battery cables before working on the engine. Remove the negative (-) lead first when disconnecting the battery. Reconnect the negative (-) lead last when reconnecting the battery.

Disabling the engine. Accidental starting can cause severe injury or death. Before working on the engine or connected equipment, disable the engine as follows: 1) Disconnect the ignition coil. 2) Remove the battery cables, negative (-) lead first. Reconnect the negative (-) lead last when reconnecting the battery. Follow these precautions to prevent the accidental starting of the engine.

Battery

 WARNING	Sulfuric acid in batteries. Can cause severe injury or death. Wear protective goggles and clothing. Battery acid may cause blindness and burn skin.
	

Battery electrolyte is a diluted sulfuric acid. Battery acid can cause severe injury or death. Battery acid can cause blindness and burn skin. Always wear splashproof safety goggles, rubber gloves, and boots when servicing the battery. Do not open a sealed battery or mutilate the battery case. If battery acid splashes in the eyes or on the skin, immediately flush the affected area for 15 minutes with large quantities of clean water. Seek immediate medical aid in the case of eye contact. Never add acid to a battery after placing the battery in service, as this may result in hazardous spattering of battery acid.

Battery acid cleanup. Battery acid can cause severe injury or death. Battery acid is electrically conductive and corrosive. Add 500 g (1 lb.) of bicarbonate of soda (baking soda) to a container with 4 L (1 gal.) of water and mix the neutralizing solution. Pour the neutralizing solution on the spilled battery acid and continue to add the neutralizing solution to the spilled battery acid until all evidence of a chemical reaction (foaming) has ceased. Flush the resulting liquid with water and dry the area.

Battery gases. Explosion can cause severe injury or death. Battery gases can cause an explosion. Do not smoke or permit flames or sparks to occur near a battery at any time, particularly when it is charging. Do not dispose of a battery in a fire. To prevent burns and sparks that could cause an explosion, avoid touching the battery terminals with tools or other metal objects. Remove all jewelry before servicing the equipment. Discharge static electricity from your body before touching batteries by first touching a grounded metal surface away from the battery. To avoid sparks, do not disturb the battery charger connections while the battery is charging. Always turn the battery charger off before disconnecting the battery connections. Ventilate the compartments containing batteries to prevent accumulation of explosive gases.

Battery short circuits. Explosion can cause severe injury or death. Short circuits can cause bodily injury and/or equipment damage. Disconnect the battery before maintenance. Remove all jewelry before servicing the equipment. Use tools with insulated handles. Remove the negative (-) lead first when disconnecting the battery. Reconnect the negative (-) lead last when reconnecting the battery. Never connect the negative (-) battery cable to the positive (+) connection terminal of the starter solenoid. Do not test the battery condition by shorting the terminals together.

Engine Backfire/Flash Fire



 WARNING	Risk of fire. Can cause severe injury or death. Do not smoke or permit flames or sparks near fuels or the fuel system.
	

Servicing the fuel system. A flash fire can cause severe injury or death. Do not smoke or permit flames or sparks near the fuel mixer, fuel line, fuel filter, or other potential sources of fuel vapors. When removing the fuel line or fuel system be aware that liquid propane can cause frostbite on contact.

Servicing the air cleaner. A sudden backfire can cause severe injury or death. Do not operate the engine with the air cleaner/silencer removed.

Combustible materials. A fire can cause severe injury or death. Engine fuels and fuel vapors are flammable and explosive. Handle these materials carefully to minimize the risk of fire or explosion. Equip the compartment or nearby area with a fully charged fire extinguisher. Select a fire extinguisher rated ABC or BC for electrical fires or as recommended by the local fire code or an authorized agency. Train all personnel on fire extinguisher operation and fire prevention procedures.



Engine Fluids and Chemical Products

 WARNING	Handling caustic engine fluids and chemical products. Can cause severe chemical burns, nausea, fainting, or death.
	<p>Most chemicals such as used engine oil, antifreeze/coolant, rustproofing agent, inhibiting oil, degreasing agent, spray paint, and adhesives are hazardous to health. Read and follow the user information found on the packaging. Avoid inhalation and skin contact. Use only in well-ventilated areas and use a protective mask when spraying. Store engine fluids and chemical products in a locked cabinet. Contact your local recycling center for disposal information and locations.</p>

Fire-damaged or burned O-rings may cause the formation of hydrofluoric acid. Contact with hydrofluoric acid may cause severe skin irritation and chemical burns. O-rings and other fluoroelastomer seals exposed to fire or temperatures above 316°C (600°F) (i.e., during welding) may decompose forming hydrofluoric acid. Avoid inhalation or skin contact. Do not incinerate O-rings. Dispose of O-ring waste material in a responsible manner.

Used engine oil. Contact with used engine oil may cause severe skin irritation. Repeated and prolonged skin exposure may have other health risks. Used engine oil is a suspected carcinogen. Avoid contact with skin. Thoroughly wash your hands and nails with soap and water shortly after handling used engine oil. Wash or dispose of clothing or rags containing used engine oil. Dispose of used engine oil in a responsible manner. Contact your local recycling center for disposal information and locations.

Exhaust System

 WARNING	Carbon monoxide. Can cause severe nausea, fainting, or death.
	<p>The exhaust system must be leakproof and routinely inspected.</p>



Carbon monoxide symptoms. Carbon monoxide can cause severe nausea, fainting, or death. Carbon monoxide is a poisonous gas present in exhaust gases. Carbon monoxide is an odorless, colorless, tasteless, nonirritating gas that can cause death if inhaled for even a short time. Carbon monoxide poisoning symptoms include but are not limited to the following:

- Light-headedness, dizziness
- Physical fatigue, weakness in joints and muscles
- Sleepiness, mental fatigue, inability to concentrate or speak clearly, blurred vision
- Stomachache, vomiting, nausea

If experiencing any of these symptoms and carbon monoxide poisoning is possible, seek fresh air immediately and remain active. Do not sit, lie down, or fall asleep. Alert others to the possibility of carbon monoxide poisoning. Seek medical attention if the condition of affected persons does not improve within minutes of breathing fresh air.

Engine Operation. Carbon monoxide can cause severe nausea, fainting, or death. Engine exhaust gases contain poisonous carbon monoxide. Carbon monoxide is an odorless, colorless, tasteless, nonirritating gas that can cause death if inhaled for even a short time. Avoid breathing exhaust fumes when working on or near the engine. Never operate the engine inside a building. Never operate the engine where exhaust gas could seep inside or be drawn into a potentially occupied building through windows, air intake vents, or other openings.

Fuel System



 WARNING	Explosive fuel vapors. Can cause severe injury or death.
	Use extreme care when handling, storing, and using fuels.

The fuel system. Explosive fuel vapors can cause severe injury or death. Vaporized fuels are highly explosive. Use extreme care when handling and storing fuels. Store fuels in a well-ventilated area away from spark-producing equipment and out of the reach of children. Never add fuel to the tank while the engine is running because spilled fuel may ignite on contact with hot parts or from sparks. Do not smoke or permit flames or sparks to occur near sources of spilled fuel or fuel vapors. Keep the fuel lines and connections tight and in good condition. Do not replace flexible fuel lines with rigid lines. Use flexible sections to avoid fuel line breakage caused by vibration. Do not operate the engine in the presence of fuel leaks, fuel accumulation, or sparks. Repair fuel systems before resuming engine operation.

Explosive fuel vapors can cause severe injury or death. Take additional precautions when using the following fuels:



Propane (LPG)—Adequate ventilation is mandatory. Because propane is heavier than air, install propane gas detectors low in a room. Inspect the detectors per the manufacturer's instructions.

Natural Gas—Adequate ventilation is mandatory. Because natural gas rises, install natural gas detectors high in a room. Inspect the detectors per the manufacturer's instructions.



 WARNING	Explosive fuel vapors. Can cause fires and severe burns.
	If a gaseous odor is detected, ventilate the area and contact an authorized service technician.

Gas fuel leaks. Explosive fuel vapors can cause severe injury or death. Fuel leakage can cause an explosion. Check the LPG vapor or natural gas fuel system for leakage by using a soap and water solution with the fuel system test pressurized to 6–8 ounces per square inch (10–14 inches water column). Do not use a soap solution containing either ammonia or chlorine because both prevent bubble formation. A successful test depends on the ability of the solution to bubble.



Hazardous Noise

 CAUTION	Hazardous noise. Can cause hearing loss.
	Never operate the engine without a muffler or with a faulty exhaust system.



Hazardous Voltage/Moving Parts

 WARNING	<p>Moving parts. Can cause severe injury or death.</p> <p>Operate the engine only when all guards and electrical enclosures are in place. Stay away from moving parts while the engine is in operation.</p>
	



Servicing the engine when it is operating. Exposed moving parts can cause severe injury or death. Keep hands, feet, hair, clothing, and test leads away from the belts and pulleys when the engine is running. Replace guards, screens, and covers before operating the engine.

 CAUTION	<p>Hazardous voltage. Electrical shock can cause injury.</p> <p>Do not touch wires while the engine is running. Stop the engine and disconnect the battery leads, negative (-) lead first, before servicing the engine.</p>
	



Heavy Equipment

 WARNING	<p>Unbalanced weight. Improper lifting can cause severe injury or death and equipment damage.</p> <p>Use adequate lifting capacity. Always maintain a safe distance from the equipment being lifted. Never stand under the equipment.</p>
	

Hot Parts

 WARNING	<p>Hot engine and exhaust system. Can cause severe injury or death.</p> <p>Do not work on the engine until it cools.</p>
	

Servicing the exhaust system. Hot parts can cause severe injury or death. Do not touch hot engine parts. The engine and exhaust system components become extremely hot during operation.

 WARNING	<p>Hot coolant and steam. Can cause severe injury or death.</p> <p>Before removing the pressure cap, stop the engine and allow it to cool. Then loosen the pressure cap to relieve pressure.</p>
	

This manual provides operating and maintenance instructions for Kohler engines. Keep this manual with the equipment for future reference. Refer to the service manual for detailed information on adjusting and servicing the engine.

Read this manual and carefully follow all procedures and safety precautions to ensure proper equipment operation and to avoid bodily injury. Read and follow the Safety Precautions and Instructions section at the beginning of this manual. Keep this manual with the equipment for future reference.

Information in this publication represents data available at the time of print. Kohler Co. reserves the right to change this publication and the products represented without notice and without any obligation or liability whatsoever.

This engine operates on either propane, liquefied petroleum gas (LPG), or natural gas (NG), which are extremely flammable and explosive. Installation and repair of LPG/NG systems must be performed only by qualified technicians. Read this manual and carefully follow all procedures and safety precautions to ensure proper equipment operation and to avoid bodily injury.

Regular maintenance is necessary for safe and efficient operation. Inspect the engine often and perform required maintenance at prescribed intervals. Service work must be performed by appropriately skilled and suitably trained maintenance personnel who are familiar with engine diagnostics and repair.

Unless otherwise specified, all units of measurement are metric, followed by the United States customary unit equivalent.

Related Literature

The following chart identifies related literature available for the KG6208 and KG6208TA engines. Only trained and qualified personnel should install or service this engine.

Literature Type	Part Number
Engine Service Manual	TP-7096
Engine Service Manual, ECM Troubleshooting and Diagnostics	TP-7097

Contact a Kohler authorized distributor/dealer for all maintenance, service, and engine parts. To find a Kohler authorized distributor/dealer, visit KOHLERPower.com or call 1-800-544-2444 (U.S. and Canada).

Service Assistance

For professional advice and conscientious service, please contact your nearest Kohler distributor or dealer.

- Visit the Kohler Co. website at KOHLERPower.com.
- Look at the labels and decals on your Kohler product or review the appropriate literature or documents included with the product.
- Call toll free in the US and Canada 1-800-544-2444.
- Outside the US and Canada, call the nearest regional office.

Headquarters Europe, Middle East, Africa (EMEA)

Kohler EMEA Headquarters
Netherlands B.V.
Kristallaan 1
4761 ZC Zevenbergen
The Netherlands
Phone: (31) 168 331630
Fax: (31) 168 331631

Asia Pacific

Kohler Asia Pacific Headquarters
Singapore, Republic of Singapore
Phone: (65) 6264-6422
Fax: (65) 6264-6455

China

North China Regional Office, Beijing
Phone: (86) 10 6518 7950
(86) 10 6518 7951
(86) 10 6518 7952
Fax: (86) 10 6518 7955

East China Regional Office, Shanghai
Phone: (86) 21 6288 0500
Fax: (86) 21 6288 0550

India, Bangladesh, Sri Lanka

India Regional Office
Bangalore, India
Phone: (91) 80 3366208
(91) 80 3366231
Fax: (91) 80 3315972

Japan, Korea

North Asia Regional Office
Tokyo, Japan
Phone: (813) 3440-4515
Fax: (813) 3440-2727

Section 1. Components and Maintenance Locations

1.1 Naturally Aspirated Engine, Side Views

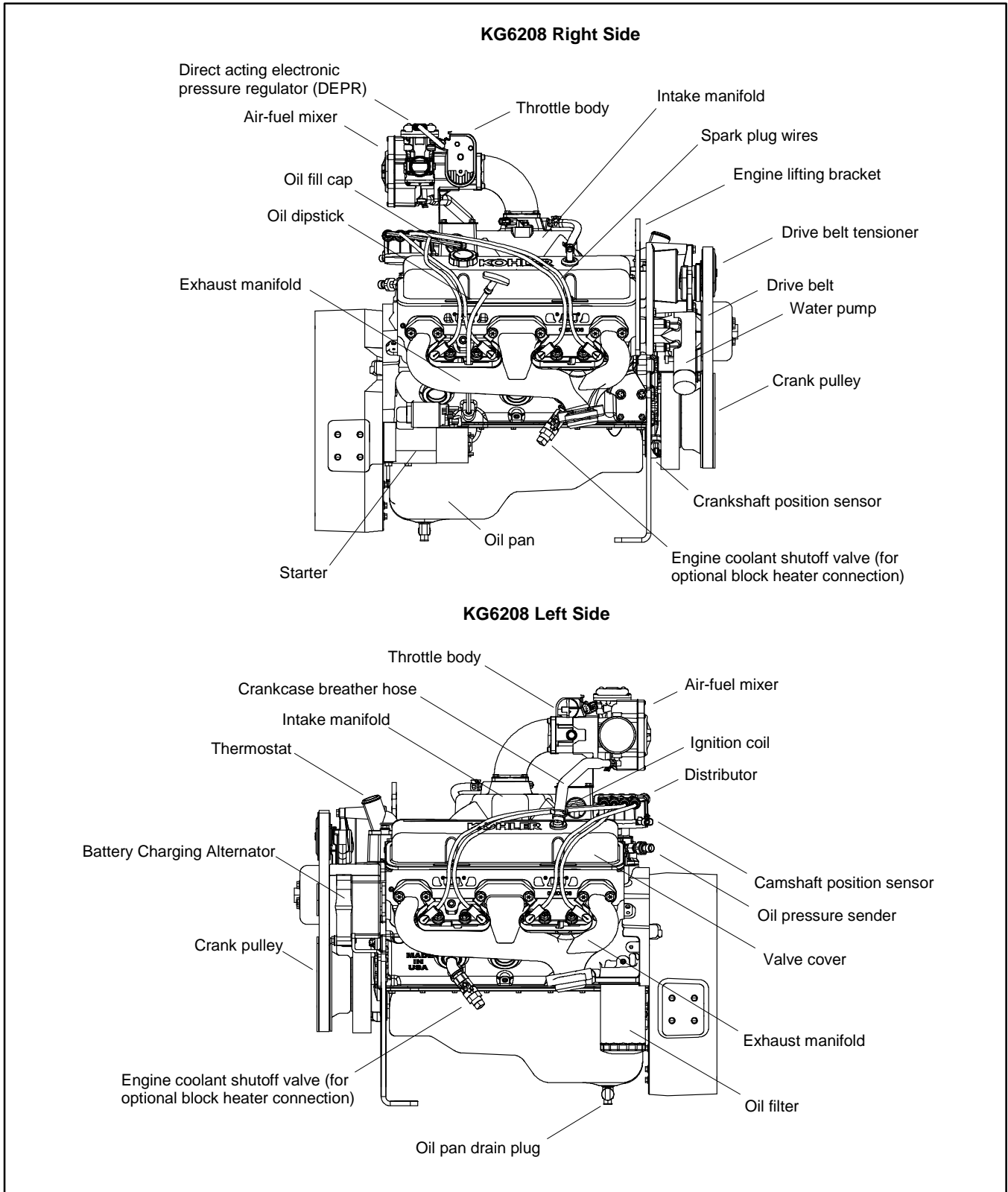

Figure 1 KG6208, Naturally Aspirated Engine Side Views

1.2 Naturally Aspirated Engine, Top and Rear Views

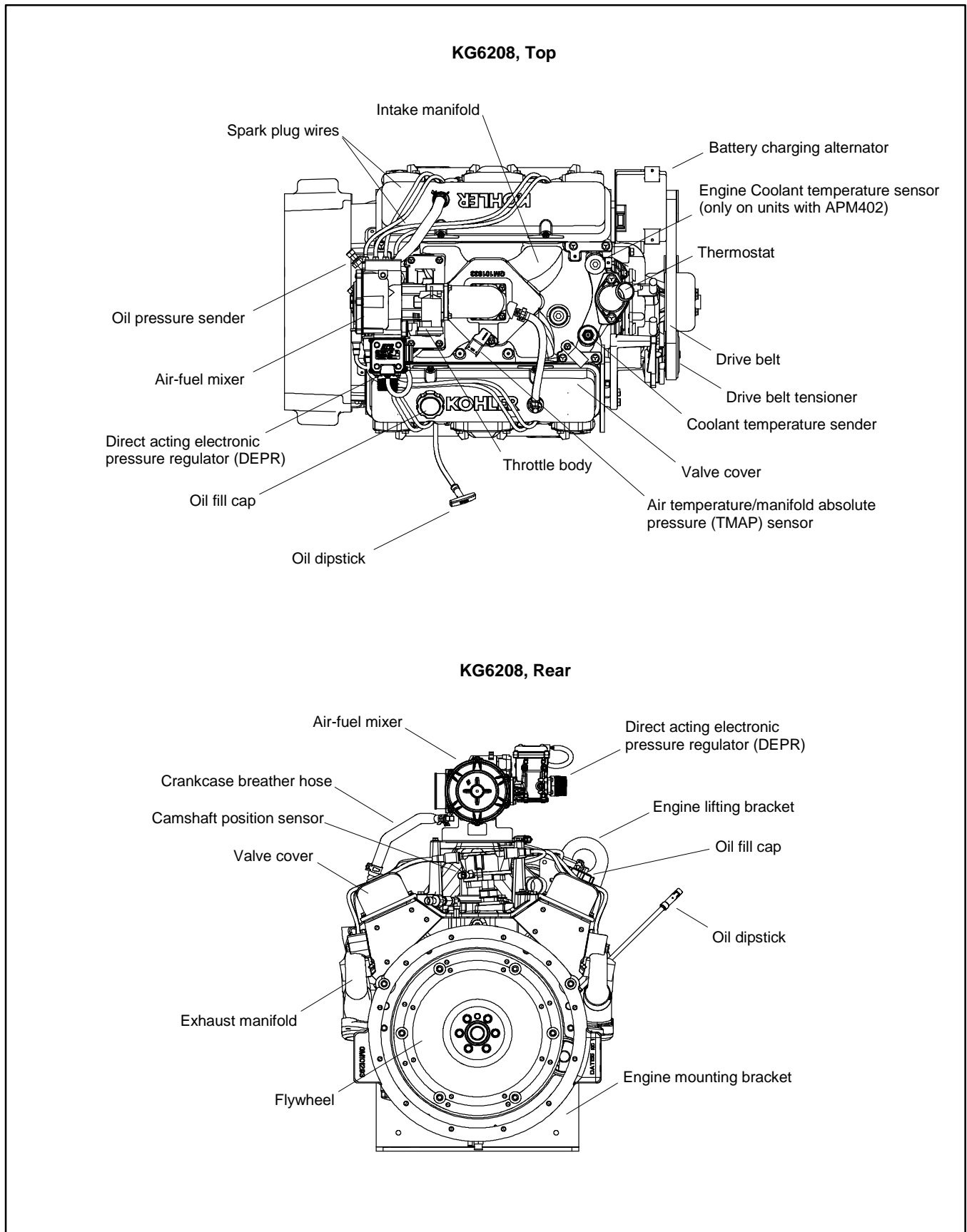

Figure 2 KG6208, Naturally Aspirated Engine Top and Rear Views

1.3 Turbocharged, Standard-Duty Engine, Side Views

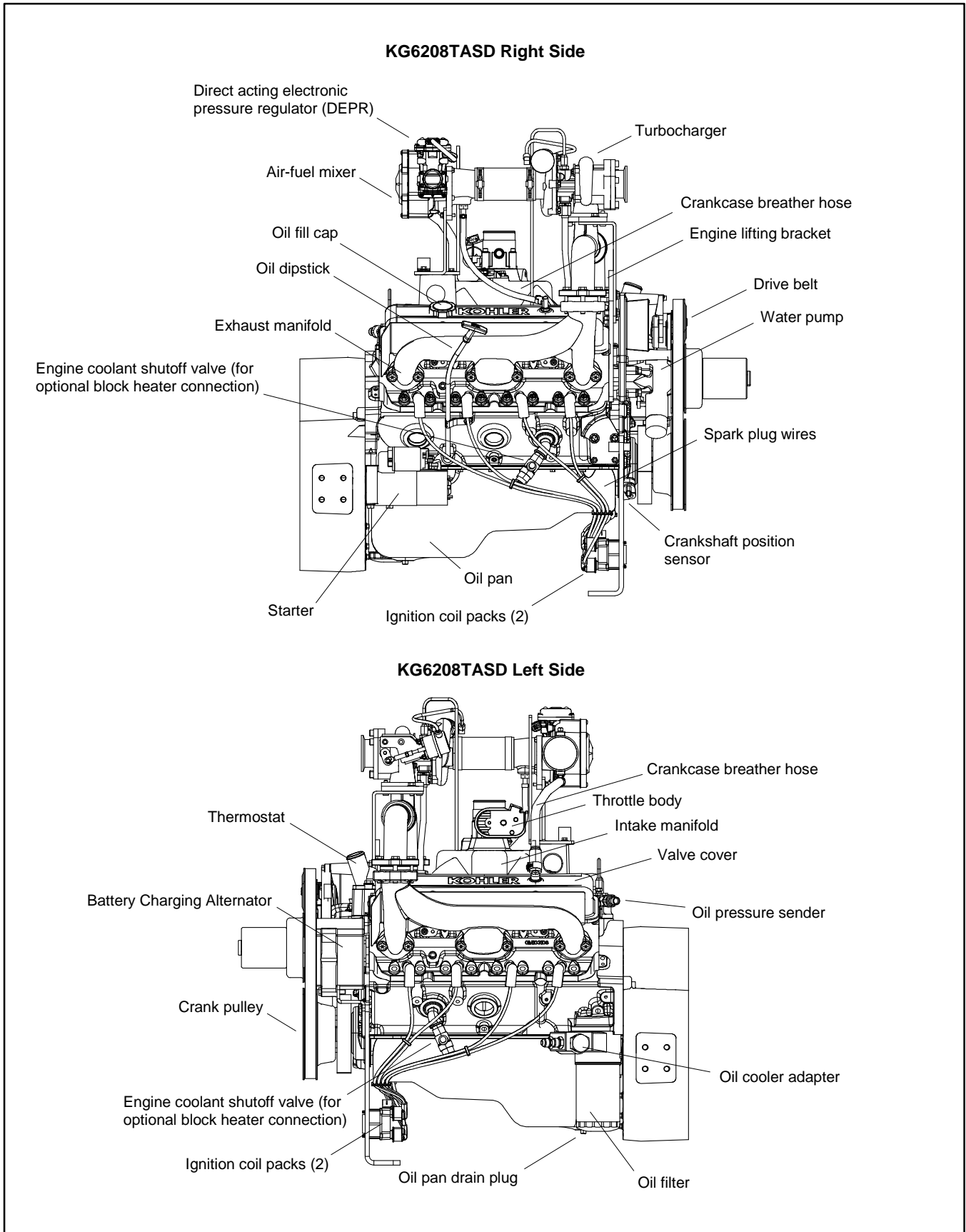

Figure 3 KG6208TASD, Standard Duty Turbocharged Engine Side Views

1.4 Turbocharged, Standard-Duty Engine, Top and Rear Views

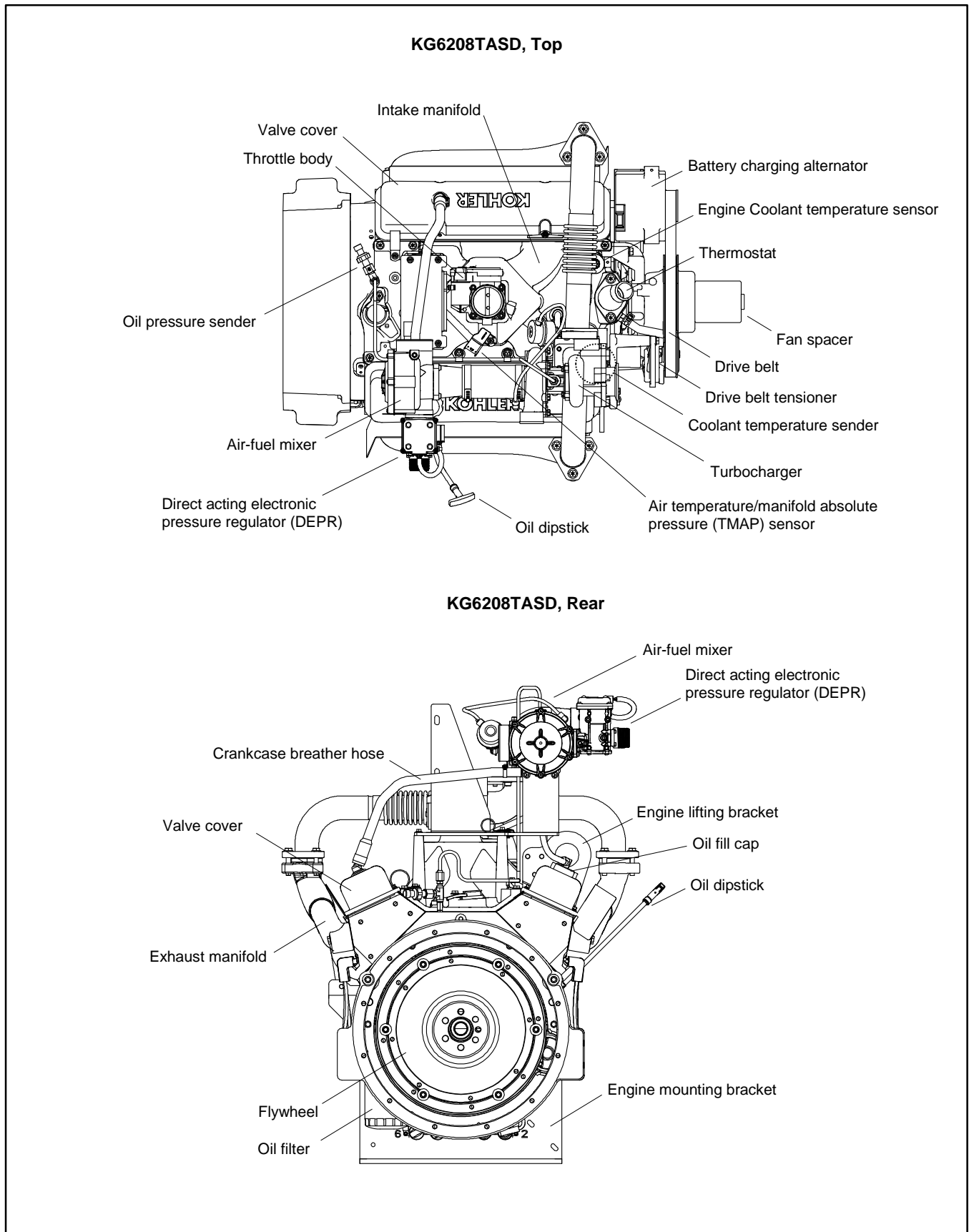

Figure 4 KG6208TASD, Standard Duty Turbocharged Engine Top and Rear Views

1.5 Turbocharged, Heavy-Duty Engine, Side Views

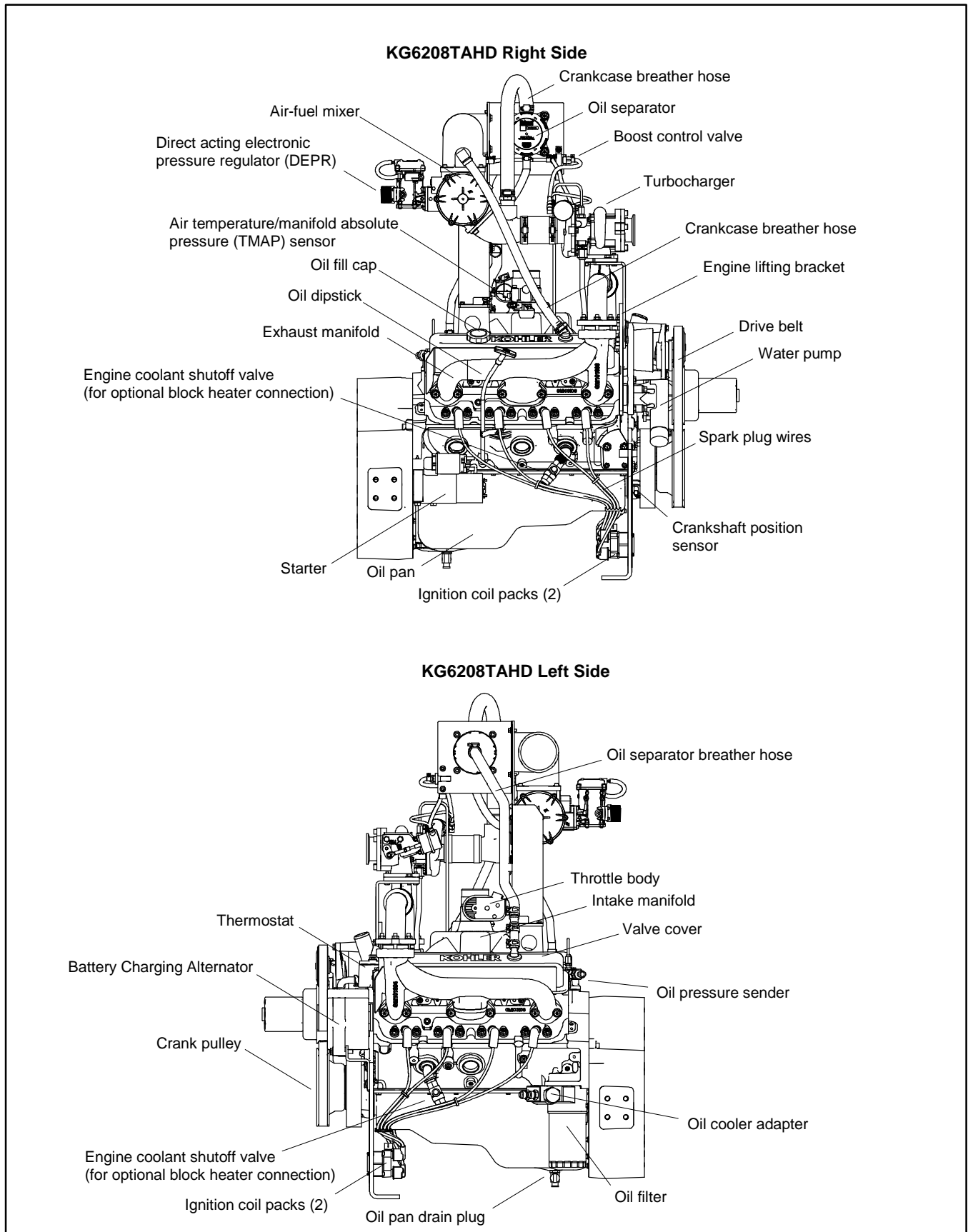

Figure 5 KG6208TAHD, Heavy Duty Turbocharged Engine Side Views

1.6 Turbocharged, Heavy-Duty Engine, Top and Rear Views

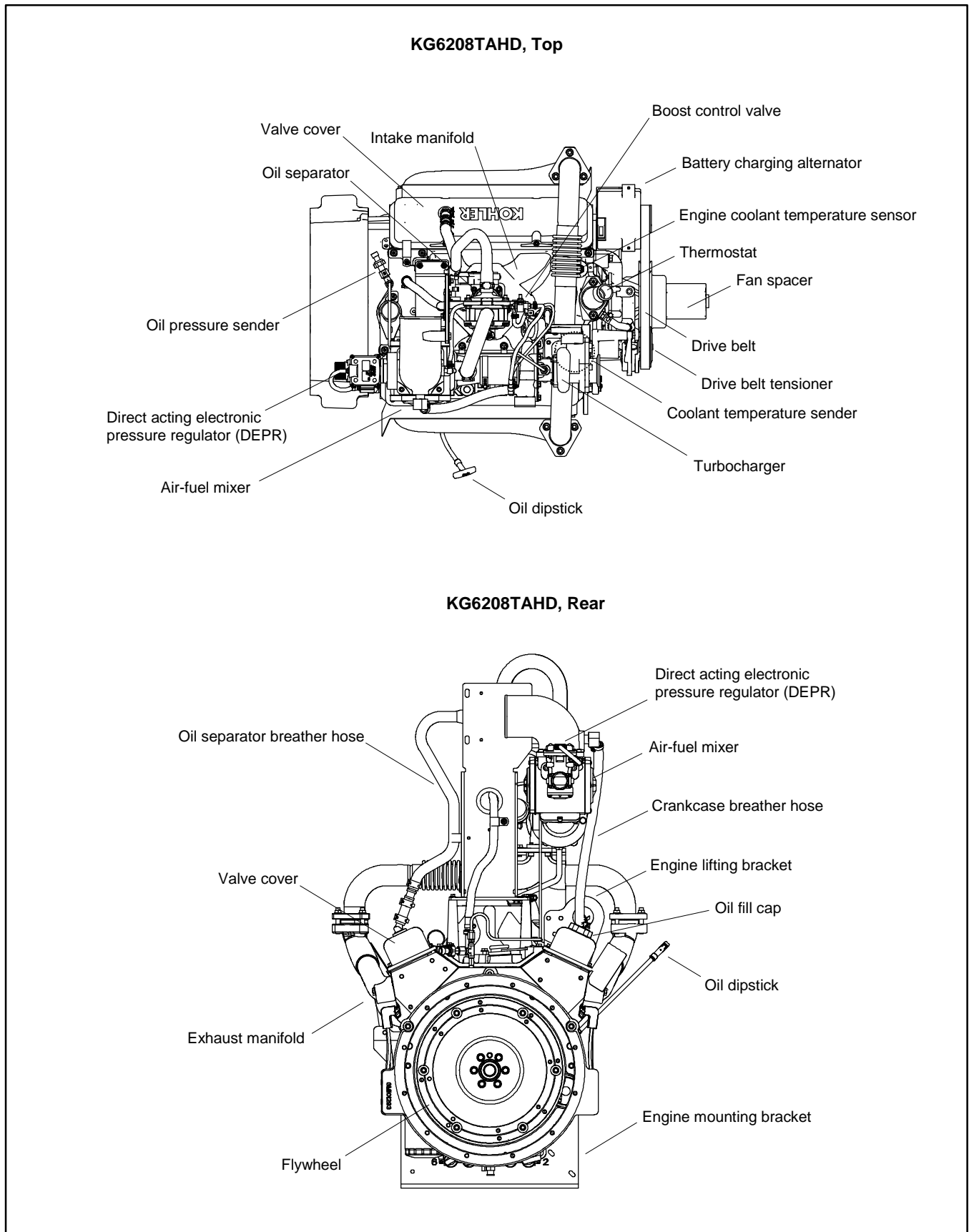

Figure 6 KG6208TAHD, Heavy Duty Turbocharged Engine Top and Rear Views

2.1 Introduction

These four-stroke internal combustion engines are certified to operate on either Propane, Liquid Petroleum Gas (LPG) or Natural Gas (NG). System configuration is factory preset for NG.

The fuel system on this engine is a closed loop design. As the engine runs, sensors located at various points within the system provide continuous operating feedback to the Engine Control Module (ECM). The ECM adjusts the engine speed, ignition timing, and fuel supply in response to changes in the applied load, surrounding air temperature, operating temperature of the engine, and amount of oxygen present in the exhaust.

Refer to the Operation Manual for the equipment using this engine for specific information on how fault codes are displayed.

Note:

Some of the fuel system components, such as the turbocharger, turbocharger oil lines, and charge air cooler, are only available on turbocharged engine models, KG6208TA.

2.2 Fuel System

2.2.1 Components

Ignition System (KG6208, Naturally Aspirated Engine Only)

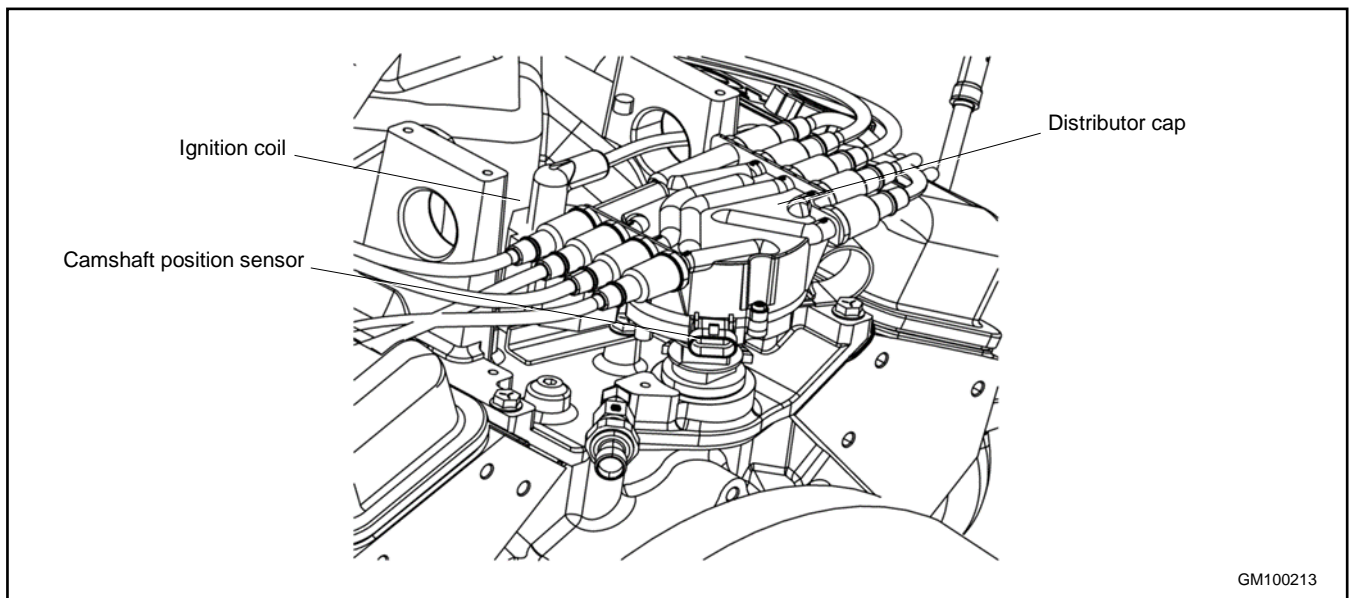

Figure 7 Ignition System, Distributor

The ignition system for the KG6208, naturally aspirated engine, consists of the ignition coil, distributor, and spark plugs. The ECM receives signals from the crankshaft position sensor and camshaft position sensor to control ignition timing. The ECM then sends a signal to the ignition coil, which in turn supplies voltage to the distributor. As the rotor in the distributor spins, voltage is supplied to the spark plugs and ignition is supplied to the cylinders.

Note:

Turbocharged engine models, KG6208TA, use ignition coil packs and do not have a distributor or camshaft position sensor.

Ignition System (KG6208TA, Turbocharged Engines Only)

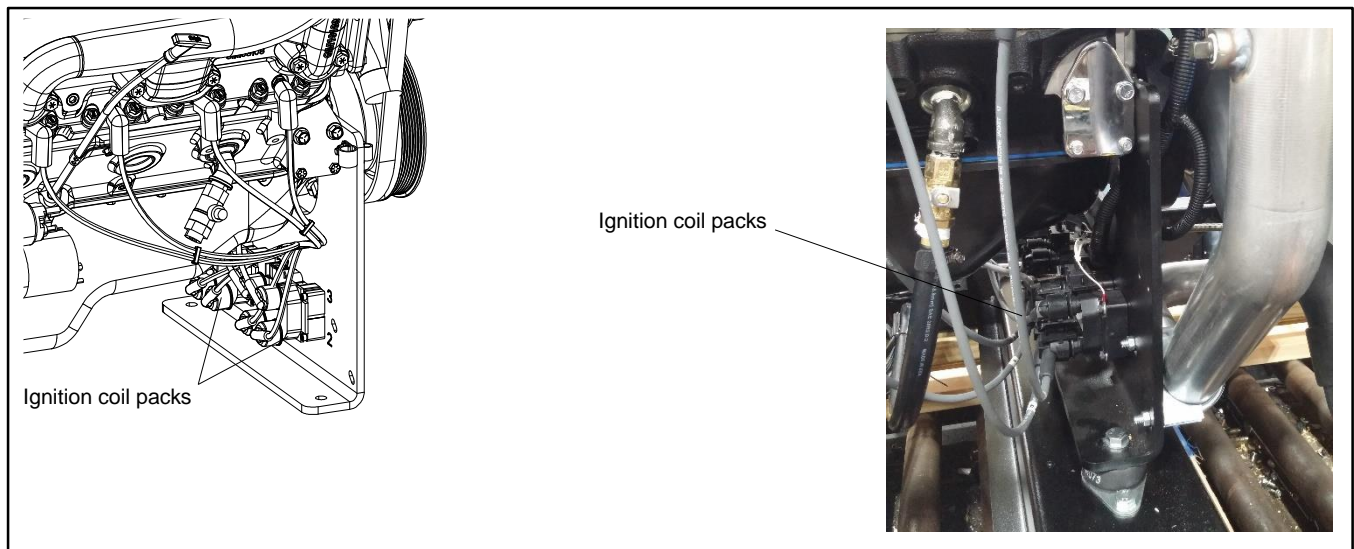

Figure 8 Ignition System, Ignition Coil

The ignition system for the KG6208TA, turbocharged engine, consists of two ignition coil packs, spark plug wires, and spark plugs. The ignition coil pack controls the spark timing for the engine.

This ignition system is a wasted-spark system. In a wasted spark system, spark is provided to two cylinders simultaneously. One spark plug fires during the compression stroke of a cylinder and creates combustion; while the other spark plug fires during the exhaust stroke and is wasted.

After receiving the crank signal, the ECM sends the ignition control packs a triggering signal that controls the timing of the ignition spark. The ignition coils then provide voltage to the spark plugs through high tension leads.

Note:

Turbocharged engine models do not have a distributor or a camshaft position sensor.

Direct Acting Electronic Pressure Regulator

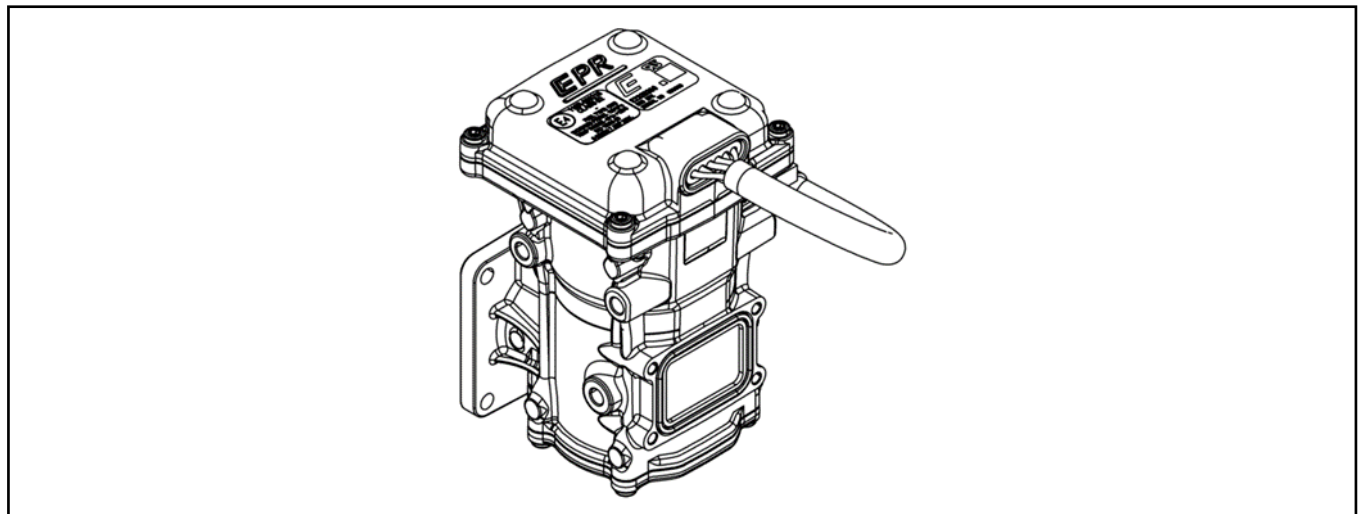

Figure 9 Fuel Pressure Regulator

The direct acting electronic pressure regulator (DEPR) controls the gaseous fuel pressure and fuel delivery. The DEPR receives fuel pressure commands from the ECM and modulates fuel pressure to the air-fuel mixer. The DEPR allows for fast and accurate gaseous fuel control to provide a combustible mixture to the engine.

Boost Control Solenoid (KG6208TAHD, Heavy-Duty Turbocharged Engines Only)

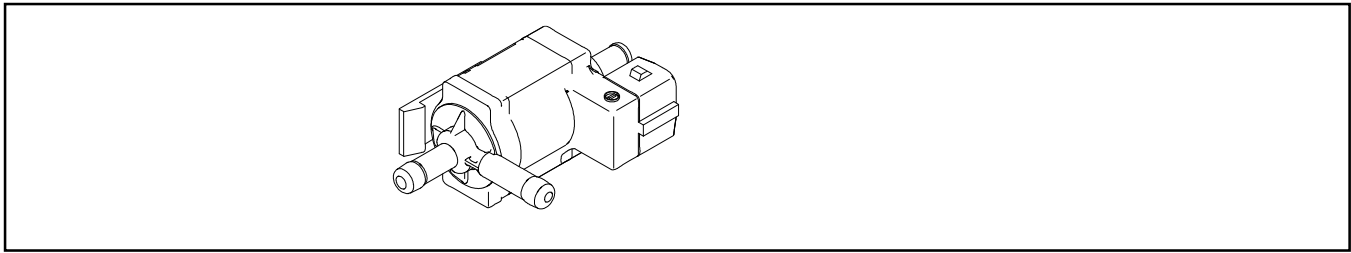

Figure 10 Boost Control Solenoid (KG6208TAHD, Heavy-Duty Turbocharged Engines Only)

The boost control solenoid is an ECM controlled valve which reduces and regulates wastegate actuator pressure. The boost control solenoid allows boost pressure to match the operating condition.

Oil Separator (KG6208TAHD, Heavy-Duty Turbocharged Engines Only)

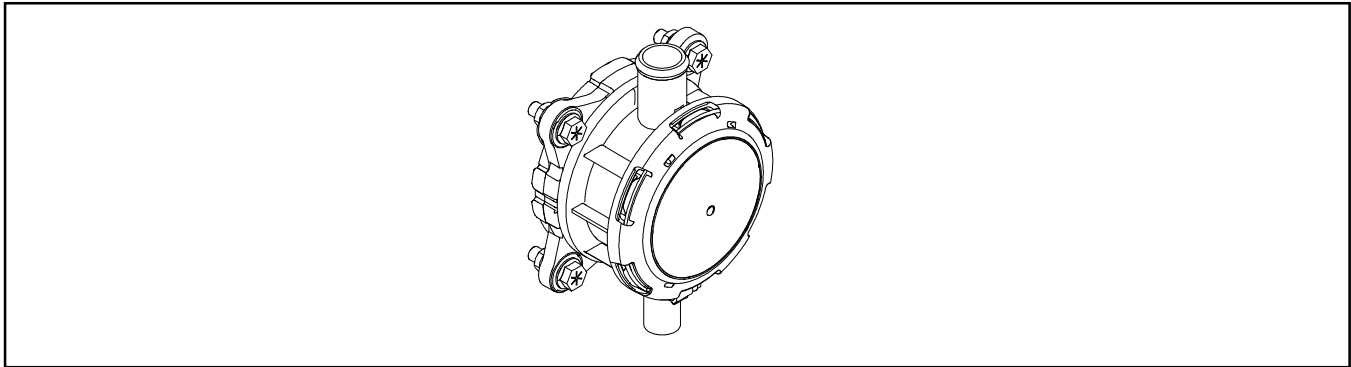

Figure 11 Oil Separator (KG6208TAHD, Heavy-Duty Turbocharged Engines Only)

The oil separator is part of the closed crankcase ventilation system. Blow-by gas in the crankcase is circulated through the oil separator. Oil is separated and drained into the engine block and the cleaned blow-by gas is circulated back into the air intake.

Air-Fuel Mixer

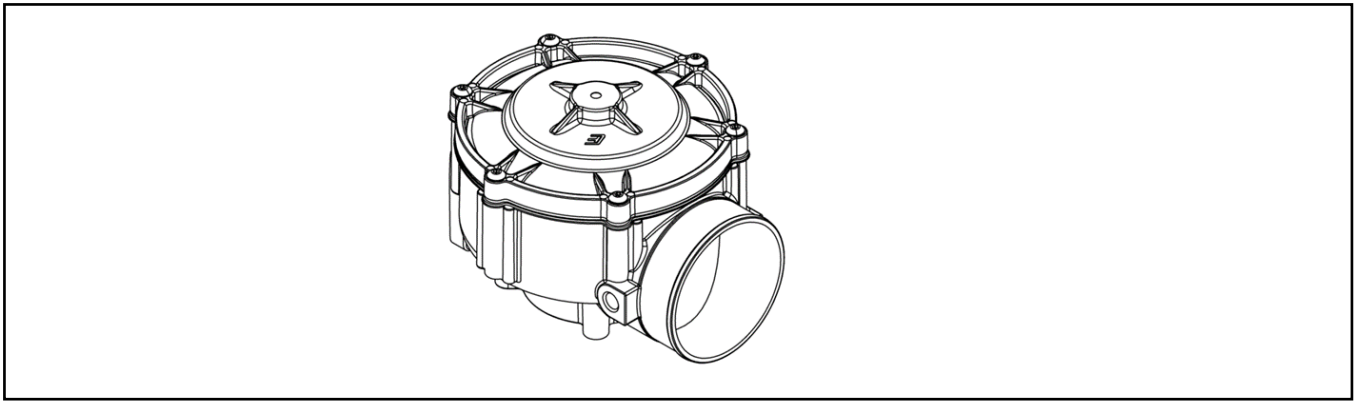

Figure 12 Air-Fuel Mixer

The air-fuel mixer is mounted in the air stream ahead of the throttle. It is a nonadjustable metering device that combines LPG/NG vapor with intake air for combustion.

NOTICE

Avoid the possibility of component damage. The air-fuel mixer is an emission control device. Components inside the mixer are specifically calibrated to meet the engine's emission requirements and should never be disassembled or rebuilt. If the mixer fails to function correctly, contact your KOHLER authorized distributor or dealer.

Throttle Body

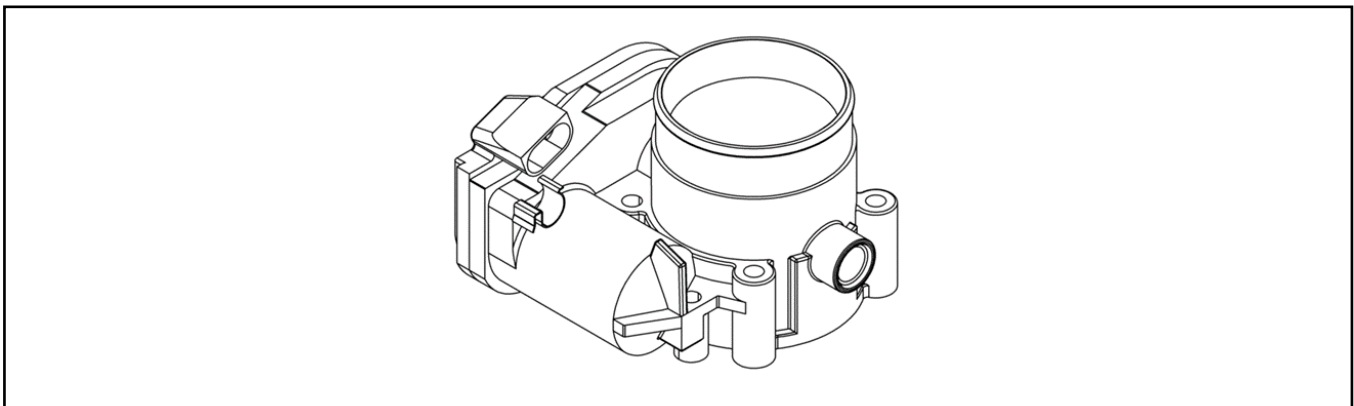

Figure 13 Throttle Body

The throttle body controls the operating speed of the engine according to input from the ECM. Defaults programmed into the ECM software, along with throttle position sensors, allow the ECM to control the overall operation of the engine in response to changing speeds and loads.

Engine Control Module (ECM)

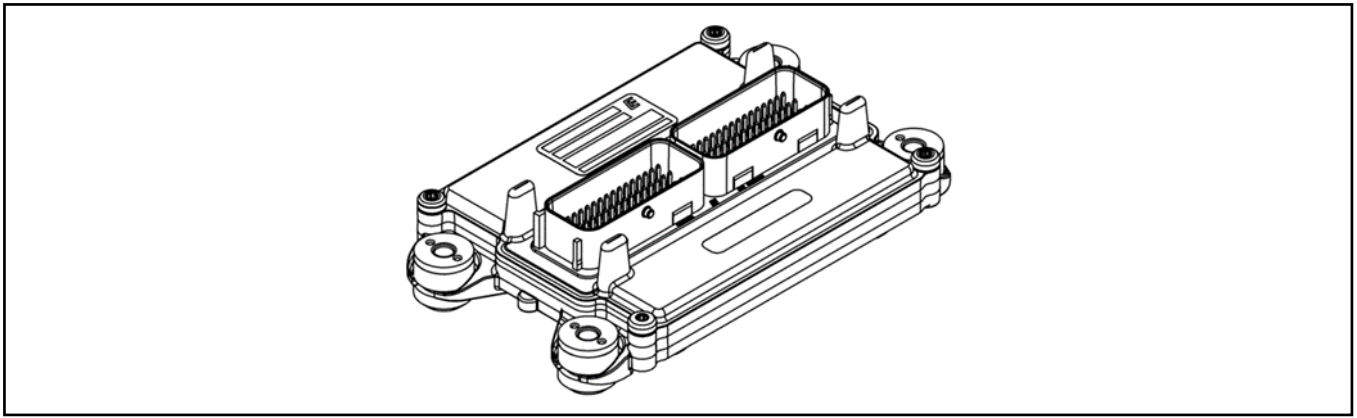

Figure 14 Engine Control Module

The ECM is a digital controller that oversees the various operating parameters of the engine. The ECM receives input data from sensors mounted to the engine and fuel system, and then outputs various signals to adjust engine operation.

The ECM also performs diagnostic functions on the fuel system. If a malfunction occurs, the ECM sends a fault signal to alert the operator to the problem. A corresponding Diagnostic Trouble Code (DTC) is generated and stored in memory within the ECM. A technician can then use a computerized diagnostic scan tool to retrieve the stored DTC number(s) and identify the problem.

Turbocharger (KG6208TA, Turbocharged Engines Only)

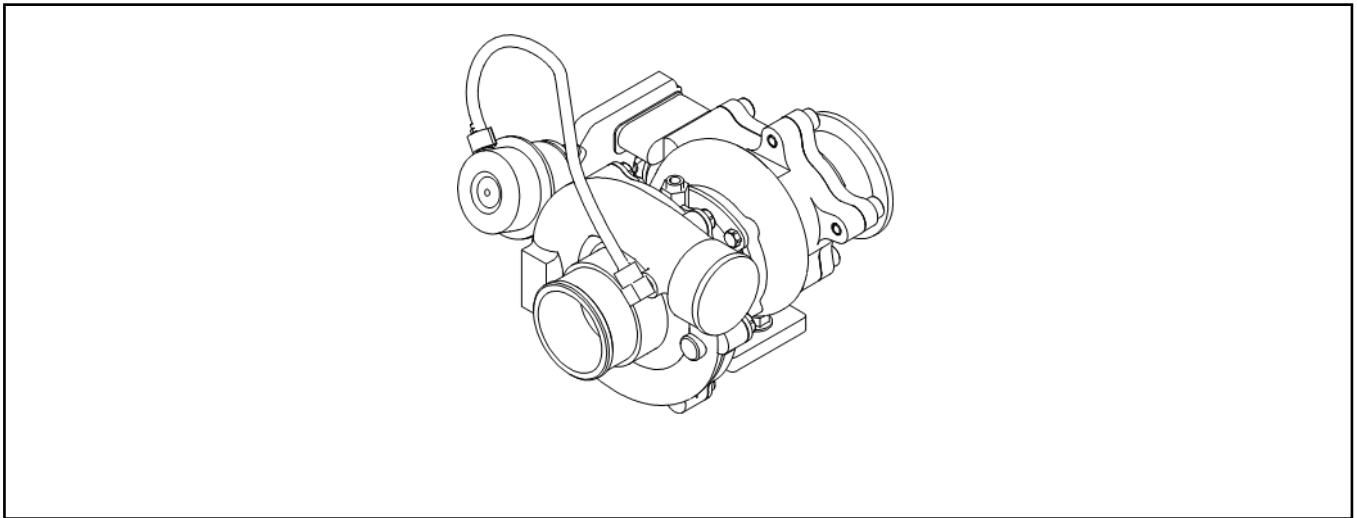

Figure 15 Turbocharger

The KG6208TA engine is equipped with a turbocharger. The turbocharger utilizes exhaust gas flowing through the turbine to spin a compressor. The turbocharger compressor increases boost pressure and density of the air/fuel mixture entering the intake manifold resulting in higher power output compared to the naturally aspirated engine. A wastegate on the turbocharger bypasses exhaust gas around the turbine when the boost pressure reaches a maximum limit.

Turbocharger Oil Lines (KG6208TA, Turbocharged Engines Only)

On the KG6208TA engine, turbocharger bearings require oil for lubrication and cooling. Oil is fed to the turbocharger bearings from the oil supply line on the top side of the bearing housing and returned to the oil sump through a line connecting the bottom side of the bearings to the sump.

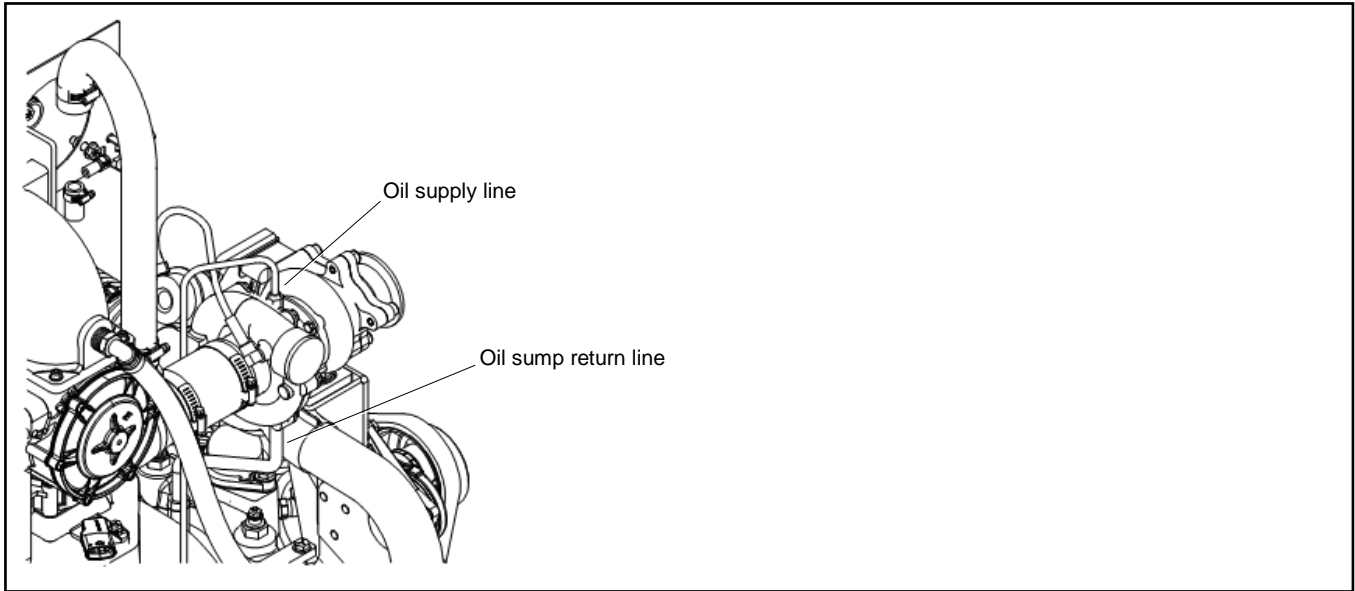

Figure 16 Turbocharger Oil Lines

Charge Air Cooler (KG6208TA, Turbocharged Engines Only)

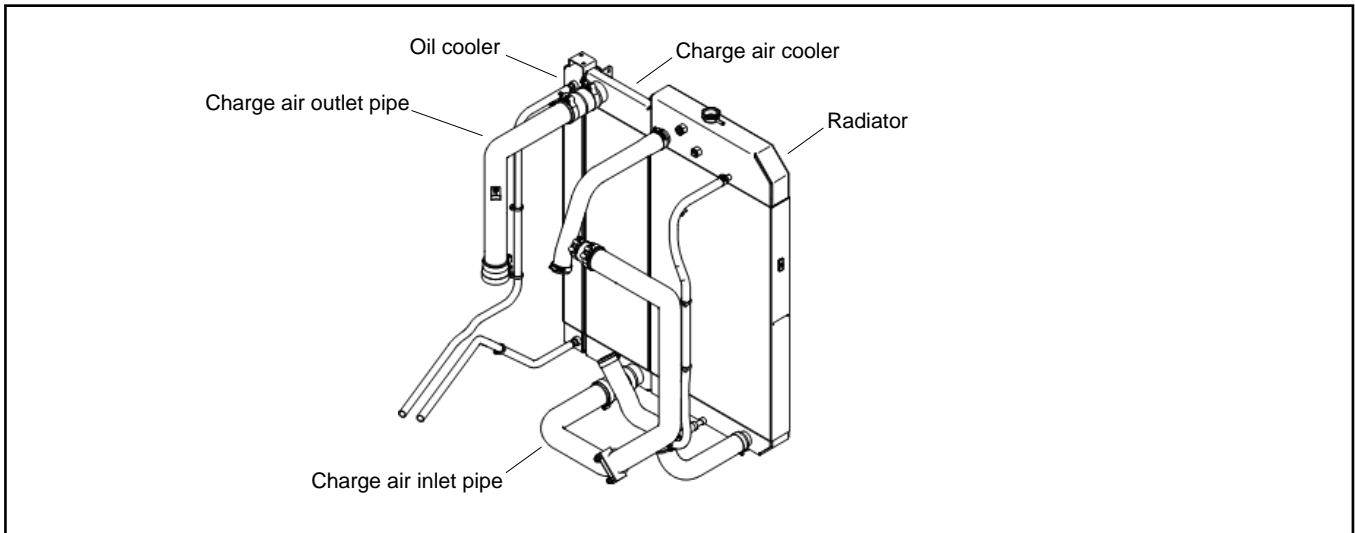

Figure 17 Charge Air Cooler

The KG6208TA engine is equipped with a charge air cooler located next to the radiator. The charge air cooler cools the compressed air-fuel mixture before it enters the intake manifold. The cooler intake manifold charge helps maintain emissions at the high power level of the turbocharged engine.

Sensors

Air Temperature/Manifold Absolute Pressure (TMAP) Sensor

The Air Temperature / Manifold Absolute Pressure (TMAP) sensor monitors the absolute pressure in the intake manifold. This sensor also measures the temperature of the incoming air. Data returned by the TMAP sensor prompts the ECM to adjust the air-fuel mixture as needed.

Camshaft Position Sensor – Naturally Aspirated Engines Only

On naturally aspirated engine models, the camshaft position sensor measures the rotary speed and camshaft turning angle. Through the camshaft position, the ECM determines the stroke, or cycle, of the engine and optimizes ignition. The sensor, which consists of a permanent magnet and coil, is integrated into the distributor. When the camshaft is turning, the position wheel (or 1 tooth wheel) passes the sensor at different speeds and causes a change of magnet resistance at the sensor to produce a changeable signal.

Coolant Temperature Sensor

The engine coolant temperature sensor provides engine coolant temperature data to the ECM. The ECM uses this data to adjust for cold starting conditions, and regulates various fuel and emission control functions.

Crankshaft Position Sensor

Crankshaft Position Sensor (CPS) measures the rotary speed and crankshaft turning angle. The ECM ensures the ignition timing for each cylinder depending on the turning signal. The sensor, which consists of a permanent magnet and coil, is installed on the timing case cover next to the crankshaft pulley. When the crankshaft is turning, the position wheel passes the sensor at different speeds and causes a change of magnet resistance at the sensor to produce a changeable signal.

Heated Exhaust Gas Oxygen (HEGO) Sensor

The Heated Exhaust Gas Oxygen (HEGO) sensor measures the amount of oxygen present in the exhaust stream to determine whether the air-fuel ratio is too rich or too lean.

Oil Pressure Sender

The engine oil pressure sender ensures sufficient lubrication throughout the engine. The sender is a pressure valve that is monitored by the ECM. A drop in pressure triggers a fault code.

Throttle Position Sensor (TPS)

The electronic throttle control device incorporates an internal Throttle Position Sensor (TPS), which provides output signals to the ECM as to the location of the throttle shaft and blade. The ECM uses the signal to monitor and adjust the engine speed.

Throttle Inlet Pressure (TIP) Sensor – Turbocharged Engines Only

On turbocharged engines, KG6208TA, the Throttle Inlet Pressure (TIP) sensor monitors the absolute pressure in the air induction system up-stream of the throttle. Data returned by the TIP sensor prompts the ECM to adjust the air-fuel mixture as needed.

2.2.2 Fuel Specifications

Note:

The fuel system installation must comply with applicable national, state, and local codes.

Fuel Type	Item	Specification		
		KG6208 Naturally Aspirated	KG6208TA Turbocharged	
Liquid Propane Gas (LPG)	Type	HD-5 or HD-10		
	Maximum fuel pressure (engine OFF, no load)	2.74 kPa (11.0 in. H ₂ O)	2.74 kPa (11.0 in. H ₂ O)	
	Minimum fuel pressure (engine ON, full load)	1.24 kPa (5.0 in. H ₂ O)	1.74 kPa (7.0 in. H ₂ O)	
Natural Gas (NG)	Supply	Standard pipeline		
	Approximate supply volume	37.257 kJ/m ³ (1000 BTU/ft. ³)		
	Minimum flow	27.6 m ³ /hr. @ 1.74 kPa (975 ft ³ /hr @ 7.0 in. H ₂ O)	KG6208TA Standard Duty	KG6208TA Heavy Duty
			34.2 m ³ /hr. @ 1.74 kPa (1210 ft ³ /hr @ 7.0 in. H ₂ O)	47.6 m ³ /hr. @ 1.74 kPa (1680 ft ³ /hr @ 7.0 in. H ₂ O)
	Allowable water vapor	Less than 112.3 kg per 1 million m ³ (Less than 7 lb. per 1 million ft. ³)		
	Maximum fuel pressure (engine OFF, no load)	2.74 kPa (11.0 in. H ₂ O)		
	Minimum fuel pressure (engine ON, full load)	1.74 kPa (7.0 in. H ₂ O)		
LPG and NG (both)	Fuel handling and supply component constraints	UL 2200: Standard for Stationary Engine Equipment Assemblies		
	Operating temperature range	0°C (32°F) to 50°C (113°F) Unaided		

Figure 18 Fuel Specifications

2.2.3 Before Starting

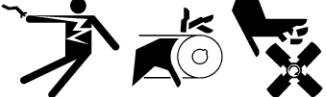
 WARNING	Accidental starting. Can cause severe injury or death.
	Disconnect the battery cables before working on the engine. Remove the negative (-) lead first when disconnecting the battery. Reconnect the negative (-) lead last when reconnecting the battery.



Disabling the engine. Accidental starting can cause severe injury or death. Before working on the engine or connected equipment, disable the engine as follows: 1) Disconnect the ignition coil. 2) Remove the battery cables, negative (-) lead first. Reconnect the negative (-) lead last when reconnecting the battery. Follow these precautions to prevent the accidental starting of the engine.

To prevent possible injury or damage to equipment, carefully read and understand all information in this Operation Manual before starting the engine. Follow the checklist below prior to each start up:



- Perform a walk-around inspection, checking for damage, fluid leaks, loose or missing fasteners, or debris.
- Check pipe and hose connections to make sure that they are tight.
- Check engine oil level; add oil as needed. Inspect engine oil for signs of deterioration or contamination. See the maintenance procedure for checking the engine oil.
- Check engine coolant level; add coolant as needed. Inspect coolant for contamination. See the maintenance procedure for checking the coolant level and condition.
- Check battery connections to ensure that they are tight with no visible corrosion. Check level of battery electrolyte and add fluid if necessary. See the maintenance procedure for checking the electrical system.
- Check and clean cooling areas, air intake areas, and external surfaces of the engine, particularly if the engine has been stored for a long period of time.
- Check to make sure that air cleaner components, shrouds, equipment covers, and guards are in place and securely fastened.
- Check all electrical connections to make sure that they are tight, including those at the alternator, starter, spark plug, and ignition coil. Repair damaged or loose wires or connectors before starting the engine.
- Check the fuel system. Make sure that all connections are secure at the fuel supply line and at all fuel system components. **Do not start the engine if you can smell leaking gas.**
- LPG only: check the fuel level in the fuel tank, and refill if necessary.

2.2.4 Starting



The specific engine starting sequence varies depending on the equipment that this engine powers. For more information, refer to the Operation Manual for the equipment using this engine.

 WARNING	Carbon monoxide. Can cause severe nausea, fainting, or death. The exhaust system must be leakproof and routinely inspected.
	

Engine Operation. Carbon monoxide can cause severe nausea, fainting, or death. Engine exhaust gases contain poisonous carbon monoxide. Carbon monoxide is an odorless, colorless, tasteless, nonirritating gas that can cause death if inhaled for even a short time. Avoid breathing exhaust fumes when working on or near the engine. Never operate the engine inside a building. Never operate the engine where exhaust gas could seep inside or be drawn into a potentially occupied building through windows, air intake vents, or other openings.

 WARNING	Moving parts. Can cause severe injury or death. Operate the engine only when all guards and electrical enclosures are in place. Stay away from moving parts while the engine is in operation.
	

Servicing the engine when it is operating. Exposed moving parts can cause severe injury or death. Keep hands, feet, hair, clothing, and test leads away from the belts and pulleys when the engine is running. Replace guards, screens, and covers before operating the engine.



 WARNING	Explosive fuel vapors. Can cause fires and severe burns. If a gaseous odor is detected, ventilate the area and contact an authorized service technician.
	



The fuel system. Explosive fuel vapors can cause severe injury or death. Vaporized fuels are highly explosive. Use extreme care when handling and storing fuels. Store fuels in a well-ventilated area away from spark-producing equipment and out of the reach of children. Never add fuel to the tank while the engine is running because spilled fuel may ignite on contact with hot parts or from sparks. Do not smoke or permit flames or sparks to occur near sources of spilled fuel or fuel vapors. Keep the fuel lines and connections tight and in good condition. Do not replace flexible fuel lines with rigid lines. Use flexible sections to avoid fuel line breakage caused by vibration. Do not operate the engine in the presence of fuel leaks, fuel accumulation, or sparks. Repair fuel systems before resuming engine operation.

If the engine does not start after 15 seconds of cranking, wait at least 15 seconds before trying again. Do not crank the starter longer than three crank cycles. After three crank cycles, the controller will display faults. Longer crank times can overheat the starter and drain the battery.

If the engine does not start after three attempts, discontinue the starting procedure. Perform troubleshooting to locate the problem(s) and correct them before trying again.

2.2.5 Cold Weather Starting

 WARNING	Handling caustic engine fluids and chemical products. Can cause severe chemical burns, nausea, fainting, or death.
	Most chemicals such as used engine oil, antifreeze/coolant, rustproofing agent, inhibiting oil, degreasing agent, spray paint, and adhesives are hazardous to health. Read and follow the user information found on the packaging. Avoid inhalation and skin contact. Use only in well-ventilated areas and use a protective mask when spraying. Store engine fluids and chemical products in a locked cabinet. Contact your local recycling center for disposal information and locations.



 WARNING	Explosive fuel vapors. Can cause fires and severe burns.
	If a gaseous odor is detected, ventilate the area and contact an authorized service technician.

The fuel system. Explosive fuel vapors can cause severe injury or death. Vaporized fuels are highly explosive. Use extreme care when handling and storing fuels. Store fuels in a well-ventilated area away from spark-producing equipment and out of the reach of children. Never add fuel to the tank while the engine is running because spilled fuel may ignite on contact with hot parts or from sparks. Do not smoke or permit flames or sparks to occur near sources of spilled fuel or fuel vapors. Keep the fuel lines and connections tight and in good condition. Do not replace flexible fuel lines with rigid lines. Use flexible sections to avoid fuel line breakage caused by vibration. Do not operate the engine in the presence of fuel leaks, fuel accumulation, or sparks. Repair fuel systems before resuming engine operation.



Cold weather puts added stress on the engine during start up. To start the engine in cold weather:

- Make sure that the engine oil is appropriate for the ambient operating temperature. See the maintenance section for fluid specifications. Drain and replace the engine oil if necessary.
- Disconnect all applied loads and/or equipment before cranking the starter.
- Allow the engine to run, unloaded, for about 5 minutes after cold weather start up.

2.2.6 Monitoring Engine Operation

 WARNING	Carbon monoxide. Can cause severe nausea, fainting, or death. The exhaust system must be leakproof and routinely inspected.
	

Engine Operation. Carbon monoxide can cause severe nausea, fainting, or death. Engine exhaust gases contain poisonous carbon monoxide. Carbon monoxide is an odorless, colorless, tasteless, nonirritating gas that can cause death if inhaled for even a short time. Avoid breathing exhaust fumes when working on or near the engine. Never operate the engine inside a building. Never operate the engine where exhaust gas could seep inside or be drawn into a potentially occupied building through windows, air intake vents, or other openings.

 CAUTION	Hazardous voltage. Electrical shock can cause injury. Do not touch wires while the engine is running. Stop the engine and disconnect the battery leads, negative (-) lead first, before servicing the engine.
	

Check for the following items as the engine runs.

- **Gas/air leaks:** check for leakage from fuel pipes, cooling pipes, or air pipes.
- **Exhaust:** check for detonation, backfire, or knocking. Watch for excessive smoke or abnormal color.
- **Noise:** listen for rattles or other abnormal noise.
- **Electrical:** check for burnt smell from hot electrical equipment.
- **Fluid leaks:** check for leaking oil or coolant.
- **Gauges:** check oil pressure, coolant temperature, and other operating parameters.

If any abnormal or unusual conditions are detected, stop the engine immediately and perform troubleshooting diagnostics before resuming operation.

2.2.7 Stopping

1. Disconnect all applied loads if possible, along with power take-off (PTO) attachments, before stopping the engine.
2. If the engine has been running under a heavy load, reduce engine speed and allow it to run for an additional 2-3 minutes before stopping. This action will help to cool the engine slightly before shutdown.

The specific engine-stopping sequence varies depending on the equipment that this engine powers. For more information, refer to the Operation Manual for the equipment using this engine.

3.1 Introduction



Preventive maintenance is critical to prolonging the life of the engine and keeping it in optimum working condition. As the engine runs, fasteners may loosen, parts may become worn, clearances change, and oil picks up dirt and contaminants. The engine may eventually become hard to start, or may exhibit other symptoms such as decreased power output or increased fuel consumption.

Regularly scheduled maintenance will help to prevent or reduce the impact of these performance issues. To keep the engine working reliably, perform all preventive maintenance tasks described in this section.

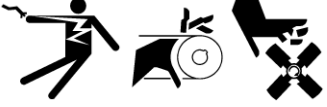

3.2 Safety Precautions and Instructions

 WARNING	<p>Accidental starting. Can cause severe injury or death.</p> <p>Disconnect the battery cables before working on the engine. Remove the negative (-) lead first when disconnecting the battery. Reconnect the negative (-) lead last when reconnecting the battery.</p>
	



Disabling the engine. Accidental starting can cause severe injury or death. Before working on the engine or connected equipment, disable the engine as follows: 1) Disconnect the ignition coil. 2) Remove the battery cables, negative (-) lead first. Reconnect the negative (-) lead last when reconnecting the battery. Follow these precautions to prevent the accidental starting of the engine.



 WARNING	<p>Handling caustic engine fluids and chemical products. Can cause severe chemical burns, nausea, fainting, or death.</p> <p>Most chemicals such as used engine oil, antifreeze/coolant, rustproofing agent, inhibiting oil, degreasing agent, spray paint, and adhesives are hazardous to health. Read and follow the user information found on the packaging. Avoid inhalation and skin contact. Use only in well-ventilated areas and use a protective mask when spraying. Store engine fluids and chemical products in a locked cabinet. Contact your local recycling center for disposal information and locations.</p>
	

Used engine oil. Contact with used engine oil may cause severe skin irritation. Repeated and prolonged skin exposure may have other health risks. Used engine oil is a suspected carcinogen. Avoid contact with skin. Thoroughly wash your hands and nails with soap and water shortly after handling used engine oil. Wash or dispose of clothing or rags containing used engine oil. Dispose of used engine oil in a responsible manner. Contact your local recycling center for disposal information and locations.



 WARNING	<p>Hot engine and exhaust system. Can cause severe injury or death.</p> <p>Do not work on the engine until it cools.</p>
	



Servicing the exhaust system. Hot parts can cause severe injury or death. Do not touch hot engine parts. The engine and exhaust system components become extremely hot during operation.

 WARNING	<p>Hot coolant and steam. Can cause severe injury or death.</p> <p>Before removing the pressure cap, stop the engine and allow it to cool. Then loosen the pressure cap to relieve pressure.</p>
	

 CAUTION	Hazardous voltage. Electrical shock can cause injury.
	Do not touch wires while the engine is running. Stop the engine and disconnect the battery leads, negative (-) lead first, before servicing the engine.

Servicing the engine when it is operating. Exposed moving parts can cause severe injury or death. Keep hands, feet, hair, clothing, and test leads away from the belts and pulleys when the engine is running. Replace guards, screens, and covers before operating the engine.

 WARNING	Moving parts. Can cause severe injury or death.
	Operate the engine only when all guards and electrical enclosures are in place. Stay away from moving parts while the engine is in operation.

 WARNING	Explosive fuel vapors. Can cause severe injury or death.
	Use extreme care when handling, storing, and using fuels.

The fuel system. Explosive fuel vapors can cause severe injury or death. Vaporized fuels are highly explosive. Use extreme care when handling and storing fuels. Store fuels in a well-ventilated area away from spark-producing equipment and out of the reach of children. Never add fuel to the tank while the engine is running because spilled fuel may ignite on contact with hot parts or from sparks. Do not smoke or permit flames or sparks to occur near sources of spilled fuel or fuel vapors. Keep the fuel lines and connections tight and in good condition. Do not replace flexible fuel lines with rigid lines. Use flexible sections to avoid fuel line breakage caused by vibration. Do not operate the engine in the presence of fuel leaks, fuel accumulation, or sparks. Repair fuel systems before resuming engine operation.

Gas fuel leaks. Explosive fuel vapors can cause severe injury or death. Fuel leakage can cause an explosion. Check the LPG vapor or natural gas fuel system for leakage by using a soap and water solution with the fuel system test pressurized to 6–8 ounces per square inch (10–14 inches water column). Do not use a soap solution containing either ammonia or chlorine because both prevent bubble formation. A successful test depends on the ability of the solution to bubble.

3.3 Fluid Specifications

3.3.1 Oil Recommendations

Kohler recommends Kohler Genuine Oil, 10W-40 or equivalent.

Kohler Genuine Oil is fully synthetic and engineered specifically for gaseous-fueled (NG/LPG) engines requiring SAE 10W-40 oil.

The oil must meet the specifications for zinc, phosphorus and ash content listed in Figure 19.

Oil Specifications	
Oil Type	Kohler Genuine Oil, 10W-40
Zinc	1000-1200 ppm
Phosphorous	1000-1200 ppm
Sulfate Ash Content	1.0% or lower

Figure 19 Engine Oil Requirements

Note:

- Do not mix different brands or types of oil.
- Do not overfill or underfill the engine's lubrication system. See "Engine Specifications."

3.3.2 Coolant Recommendations

Use only a mixture of 50% long life coolant and 50% clean, softened water to inhibit rust/corrosion and prevent freezing.

A solution of 50% long life coolant provides freezing protection to -37°C (-34°F) and overheating protections to 149°C (300°F). A coolant solution with less than 50% long life coolant may not provide adequate freezing and overheating protection. Do not mix long life coolants and conventional coolants. **Do not mix different types and/or colors of long life coolants.**

3.4 Periodic Maintenance Schedule

Engine parts experience wear at different rates. Technical maintenance tasks, therefore, are required at different intervals throughout the life of the engine. Tasks performed after the first 10 hours of operation, for example, must be repeated after 20 hours, 30 hours, and so forth. Perform and repeat these tasks according to the periodic schedule below.

Daily (Before Starting)
Check the engine oil level and replenish as needed.
Check the coolant level and replenish as needed.
Check for fluid leaks and the tightness of clamps and hoses.
Check that all shrouds, equipment covers, and guards are in place and securely fastened.
Check for loose electrical connections such as battery, alternator, ignition coil, or spark plug wires.
Check the battery connections for tightness and signs of corrosion.
Check for leaks, hissing, and gas odor.
Weekly or Every 10 Hours of Operation
Check the main tank supply level (LPG only).
Quarterly or Every 20 Hours of Operation
Check the battery voltage; charge or replace as needed.
Check the air cleaner element (refer to the Operation Manual of the equipment using this engine). ♦
Check the fuel lines and connections.
Yearly or Every 120 Hours of Operation
Check and clean the radiator exterior.
Check the battery fluid level.
Check the battery for cracks and corrosion.
Clean battery cables. ♦
Check the fuel pressure.
Check the drive belt for cracks, breaks, or splitting.
Yearly or Every 150 Hours of Operation
Change the engine oil and filter. ♦
Inspect crankcase breather hose.
Check spark plugs.
3 Years or Every 400 Hours of Operation
Change the air cleaner element (see equipment operation manual). ♦
3 Years or Every 500 Hours of Operation
Check the air induction (air-fuel mixer, throttle body, DEPR, intake elbow, intake manifold) for leaks.
Check the intake manifold for vacuum leaks.
Check the spark plug and electrode gap. Adjust gap if necessary. Recommended replacement is 1000 hours of operation or at 500 hours of operation if damaged or discolored.
Check the spark plug wires for cuts, abrasions, or hardening and replace as needed.
Check the ignition coil wires and replace as needed.
Change the engine coolant. §
Check the condition of the hoses and replace as needed.
5 Years or Every 2000 Hours of Operation
Check exhaust manifold for leaks and replace as needed.
Check the exhaust piping for leaks.
Check HEGO (oxygen) sensor connections and wires.
Inspect wiring for cuts, abrasions, or corrosion.
Inspect vacuum lines and fittings for cracks, breaks, or splitting and replace as needed..
Check the fuel shutoff valve operation.
Change the spark plug wires.
Change the distributor cap and rotor.
♦ Service more frequently under extremely dusty/dirty conditions. § Long-life coolant is recommended. When long-life coolant is used, the change interval is 5000 hours or 5 years. Do not mix coolant types.

3.5 Engine

3.5.1 Check Engine Oil

Check the engine oil level daily before starting the engine. Inspect the oil for signs of deterioration, discoloration, thinning, or water contamination. If any of these conditions exist, the oil quality has been compromised and should be replaced.

Required materials:

- Clean, dry cloth.
- Fresh engine oil. (See the section "Oil Recommendations")

Procedure:

1. Stop the engine and allow it to cool.
2. Pull out the oil dipstick. See Figure 20.

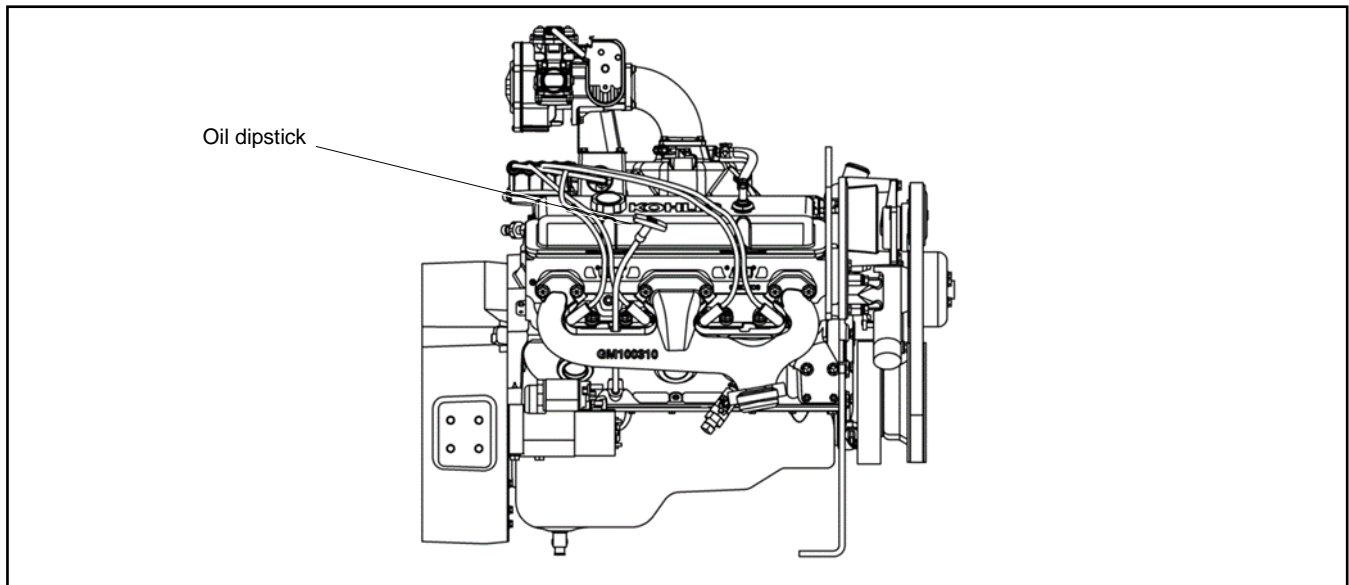

Figure 20 Oil Dipstick Location

3. Wipe the end of the dipstick with a clean, dry cloth.
4. Insert the dipstick into the engine.
5. Pull out the dipstick again to check the oil level. The oil level should be maintained between the Full and Add marks. See Figure 21.

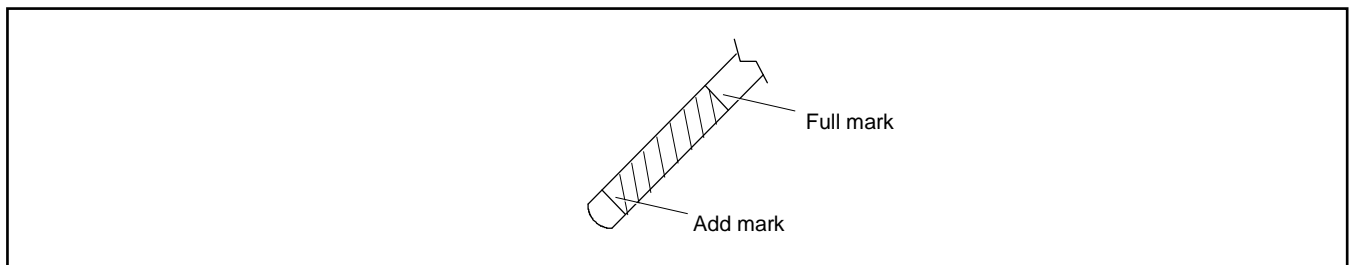

Figure 21 Oil Dipstick

6. If the oil level is below the add mark, check for leaks. If no leaks are found, open the oil fill cap. Wipe the oil fill cap clean, and add oil up to the Full mark. See Figure 22.
7. If oil leaks are found, repair them before operating the engine.

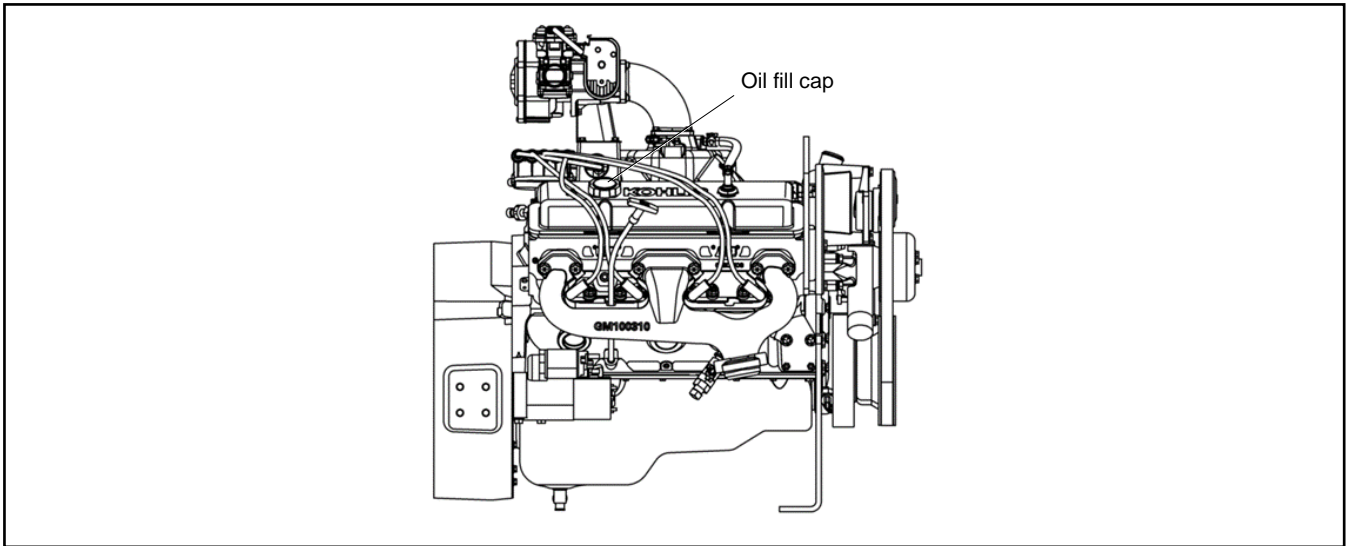





Figure 22 Oil Fill Cap

3.5.2 Change Engine Oil and Oil Filter



Change the engine oil and filter every 150 hours of operation. Replace the engine oil and filter more often if the machine is being run in excessively dirty or dusty conditions.

 WARNING	<p>Accidental starting. Can cause severe injury or death.</p> <p>Disconnect the battery cables before working on the engine. Remove the negative (-) lead first when disconnecting the battery. Reconnect the negative (-) lead last when reconnecting the battery.</p>
	



Disabling the engine. Accidental starting can cause severe injury or death. Before working on the engine or connected equipment, disable the engine as follows: 1) Disconnect the ignition coil. 2) Remove the battery cables, negative (-) lead first. Reconnect the negative (-) lead last when reconnecting the battery. Follow these precautions to prevent the accidental starting of the engine.

 WARNING	<p>Handling caustic engine fluids and chemical products. Can cause severe chemical burns, nausea, fainting, or death.</p> <p>Most chemicals such as used engine oil, antifreeze/coolant, rustproofing agent, inhibiting oil, degreasing agent, spray paint, and adhesives are hazardous to health. Read and follow the user information found on the packaging. Avoid inhalation and skin contact. Use only in well-ventilated areas and use a protective mask when spraying. Store engine fluids and chemical products in a locked cabinet. Contact your local recycling center for disposal information and locations.</p>
	

Used engine oil. Contact with used engine oil may cause severe skin irritation. Repeated and prolonged skin exposure may have other health risks. Used engine oil is a suspected carcinogen. Avoid contact with skin. Thoroughly wash your hands and nails with soap and water shortly after handling used engine oil. Wash or dispose of clothing or rags containing used engine oil. Dispose of used engine oil in a responsible manner. Contact your local recycling center for disposal information and locations.

 WARNING	Explosive fuel vapors. Can cause fires and severe burns.
	If a gaseous odor is detected, ventilate the area and contact an authorized service technician.

The fuel system. Explosive fuel vapors can cause severe injury or death. Vaporized fuels are highly explosive. Use extreme care when handling and storing fuels. Store fuels in a well-ventilated area away from spark-producing equipment and out of the reach of children. Never add fuel to the tank while the engine is running because spilled fuel may ignite on contact with hot parts or from sparks. Do not smoke or permit flames or sparks to occur near sources of spilled fuel or fuel vapors. Keep the fuel lines and connections tight and in good condition. Do not replace flexible fuel lines with rigid lines. Use flexible sections to avoid fuel line breakage caused by vibration. Do not operate the engine in the presence of fuel leaks, fuel accumulation, or sparks. Repair fuel systems before resuming engine operation.

 WARNING	Hot engine and exhaust system. Can cause severe injury or death.
	Do not work on the engine until it cools.

Servicing the exhaust system. Hot parts can cause severe injury or death. Do not touch hot engine parts. The engine and exhaust system components become extremely hot during operation.

Required materials:

- Fresh engine oil (refer to the oil recommendations in the maintenance section)
- Collection container for drained oil
- Replacement oil filter
- Oil filter wrench
- Clean, dry cloth
- Drop cloth to protect work surface

Change the engine oil and oil filter:

1. Stop the engine and allow it to cool.
2. Place a drop cloth and collection container beneath the oil drain valve. See Figure 23.

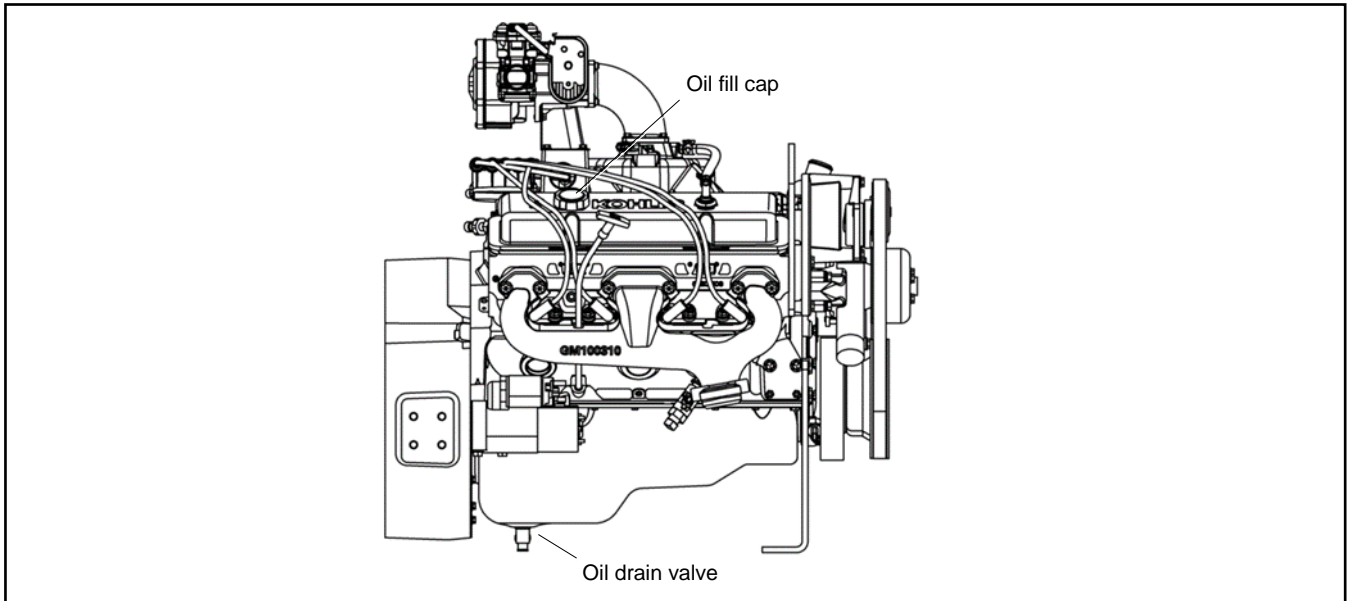

Figure 23 Oil Fill and Drain Valve Location

3. Open the oil drain valve and allow the oil to drain into the container.
4. Using an oil filter wrench, remove the old oil filter.
5. Wipe the oil filter installation surface clean with a dry cloth. Inspect the installation surface for damage. See Figure 24.

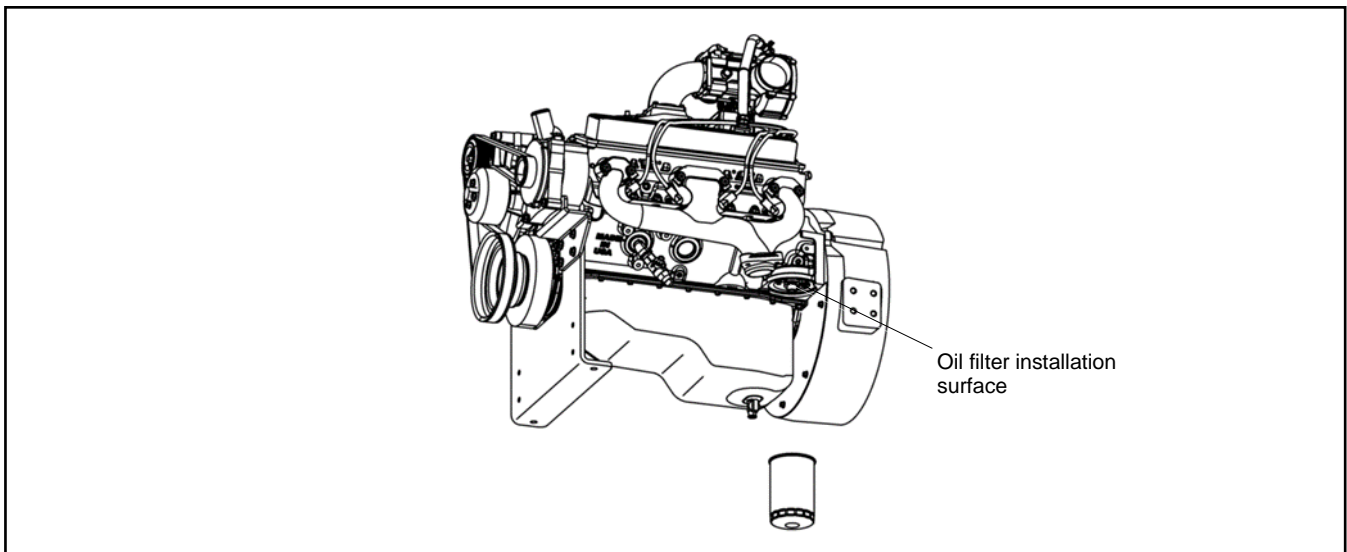

Figure 24 Oil Filter Installation Location

6. Apply a thin film of fresh oil to the gasket of the new oil filter.
7. Lightly screw in the new oil filter by hand until you feel resistance and then tighten the filter an additional 3/4 turn.
8. Close the oil drain valve.
9. Add fresh oil through the oil fill cap.
10. Check engine oil level, making sure that the level lies between the Full and Add marks on the dipstick. See Figure 25.
11. Install and tighten the oil fill cap.

12. Start and run the engine without load for approximately 5 minutes. This will ensure that the fresh engine oil is distributed to each friction surface.

Note:

Dispose of used engine oil and oil filters in accordance with local environmental regulations.

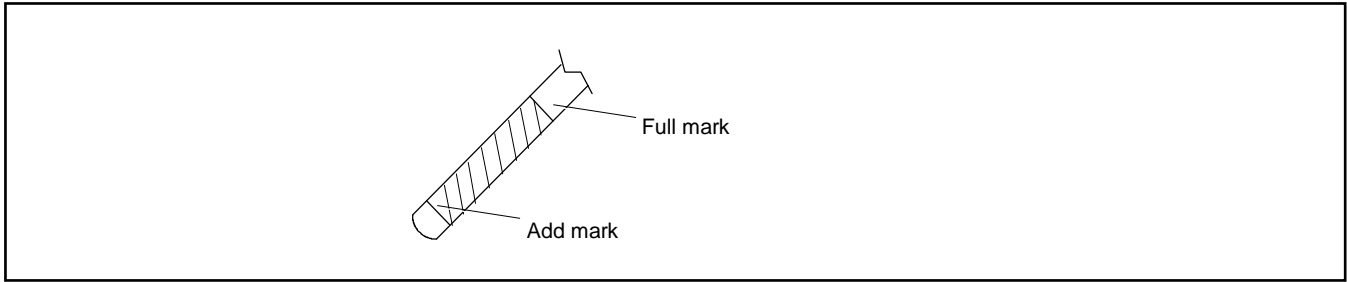

Figure 25 Oil Dipstick

3.5.3 Check and Clean the Air Filter



Refer to the Operation Manual for the equipment using this engine.

3.5.4 Replace the Air Filter

Refer to the Operation Manual for the equipment using this engine.

3.5.5 Check, Adjust and Replace the Spark Plugs

Damaged, loose, or improperly adjusted spark plugs can overheat or cause engine problems such as misfiring, hesitation, or knocking. Check the spark plugs after every 500 hours of operation

 CAUTION	<p>Hazardous voltage. Electrical shock can cause injury.</p> <p>Do not touch wires while the engine is running. Stop the engine and disconnect the battery leads, negative (-) lead first, before servicing the engine.</p>
 WARNING	<p>Hot engine and exhaust system. Can cause severe injury or death.</p> <p>Do not work on the engine until it cools.</p>

Servicing the exhaust system. Hot parts can cause severe injury or death. Do not touch hot engine parts. The engine and exhaust system components become extremely hot during operation.

Required materials:

- Spark plug wrench
- Torque wrench
- Spark plug gap tool
- Clean, dry cloth
- Replacement spark plugs. See spark plug specifications in the Specifications section.

Procedure:

1. Stop the engine and allow it to cool.

Note:

Label or mark spark plug wires before disconnecting. Spark plug wires must be reconnected in the same order as removed.

2. Use a cloth to wipe dirt and oil away from the area around each of the four spark plug wires. See Figure 26.

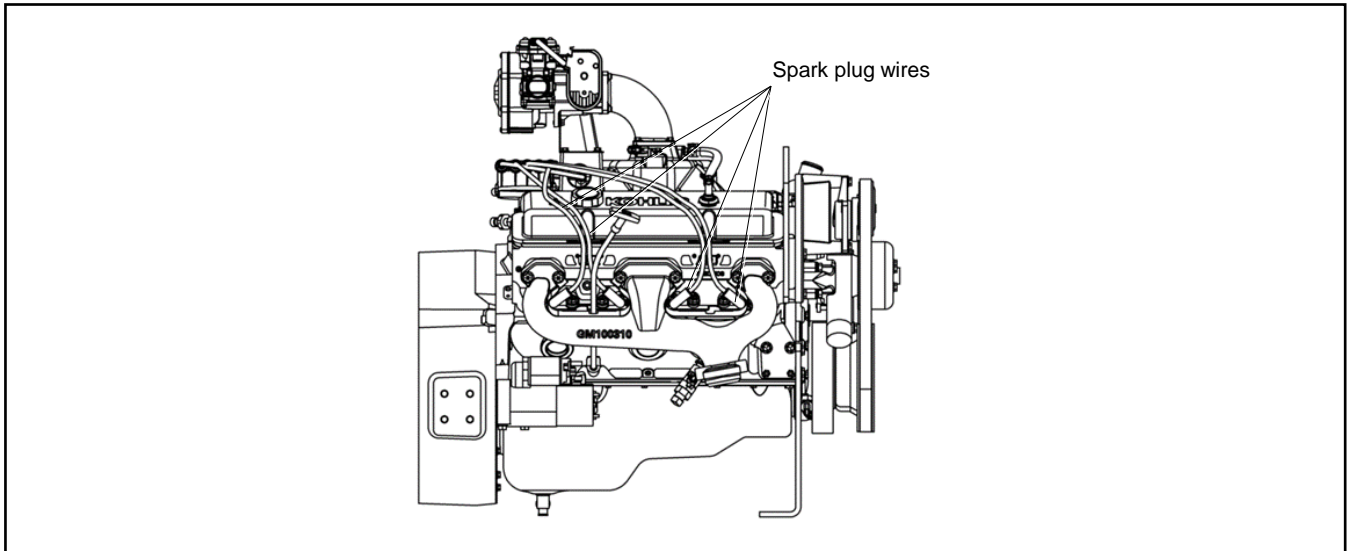

Figure 26 Spark Plug Wires

3. Disconnect the spark plug wires.
4. Use a spark plug wrench to remove the spark plugs.
5. Inspect the body of each spark plug for cracks, damage, or discoloration and check that the spark plug washer is in good condition.
6. Inspect the electrodes on each spark plug. See Figure 27. The electrodes should be light brown. If the electrode appears to be burned, covered with soot, or fouled with oil, replace the spark plug.

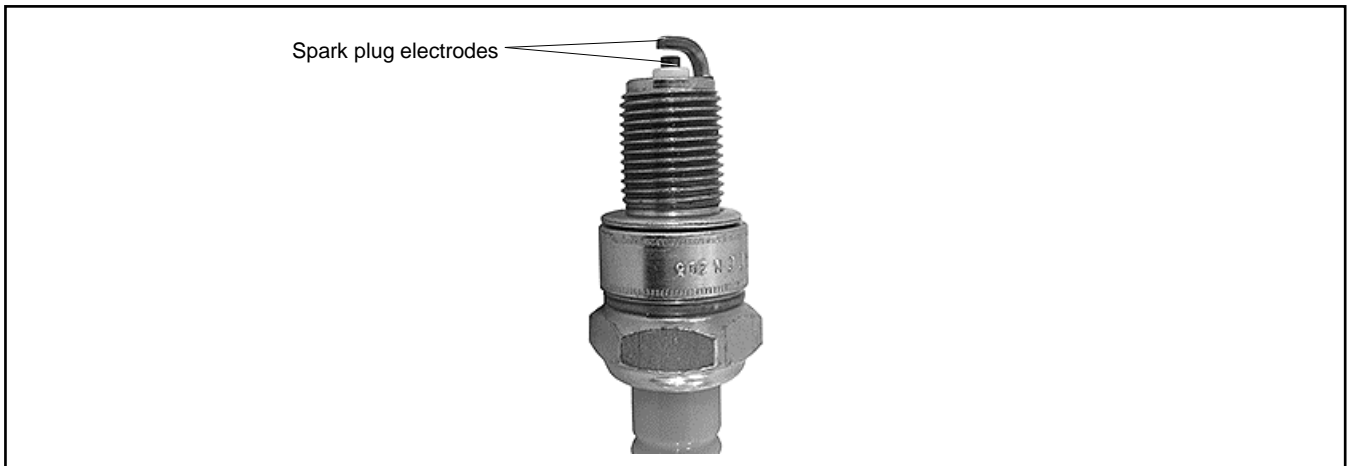

Figure 27 Spark Plug Electrodes

7. Use a spark plug gap tool to measure the gap on each spark plug. Adjust the gap to specification. See Figure 28.

Spark Plug Gap	
KG6208	0.76 mm (0.03 in.)
KG6208TA	0.4 mm (0.016 in.)

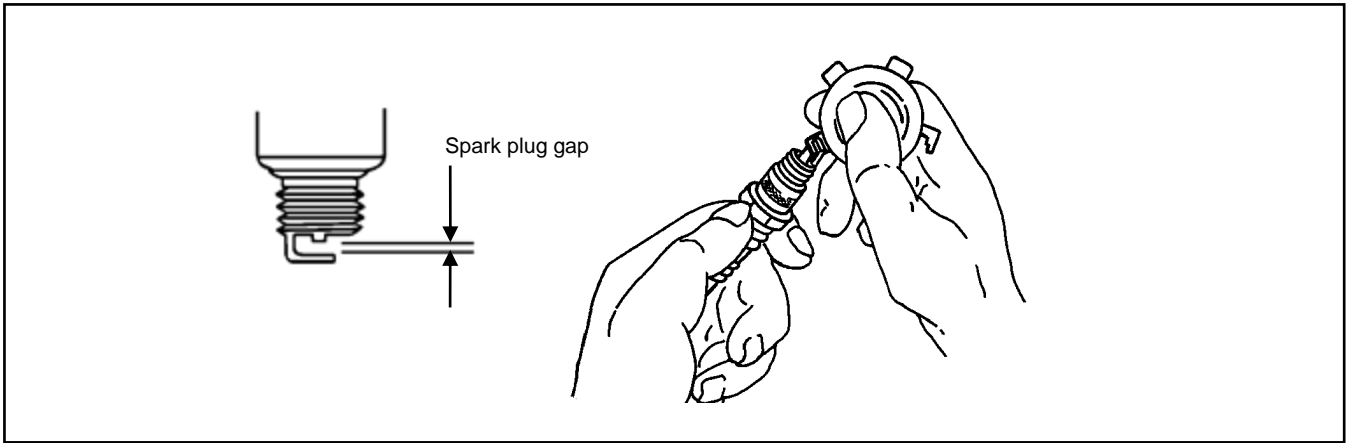

Figure 28 Spark Plug Gap

8. Thread the spark plugs into the cylinder head.
9. Tighten the spark plugs to specification.

Spark Plug Torque	
KG6208 and KG6208TA	27 Nm (20 ft. lb.)

10. Reconnect the spark plug wires to the spark plugs.

3.5.6 Ignition Timing



On naturally aspirated models, KG6208, the ignition system consists of a distributor and an ignition coil which provide voltage to the spark plugs. The ECM uses information from the camshaft and crankshaft position sensors to optimize ignition timing.



On turbocharged models, KG6208TA, the ignition system consists of two ignition coil packs which provide voltage to the spark plugs. The ECM uses information from the crankshaft position sensors to optimize ignition timing.

Contact your Kohler authorized distributor/dealer for assistance with ignition-related performance issues.

3.6 Electrical System

3.6.1 Check Battery and Connections

 WARNING	Sulfuric acid in batteries. Can cause severe injury or death. Wear protective goggles and clothing. Battery acid may cause blindness and burn skin.
	

 WARNING	Explosion. Can cause severe injury or death. Relays in the battery charger cause arcs or sparks. Locate the battery in a well-ventilated area. Isolate the battery charger from explosive fumes.
	

Battery electrolyte is a diluted sulfuric acid. Battery acid can cause severe injury or death. Battery acid can cause blindness and burn skin. Always wear splashproof safety goggles, rubber gloves, and boots when servicing the battery. Do not open a sealed battery or mutilate the battery case. If battery acid splashes in the eyes or on the skin, immediately flush the affected area for 15 minutes with large quantities of clean water. Seek immediate medical aid in the case of eye contact. Never add acid to a battery after placing the battery in service, as this may result in hazardous spattering of battery acid.

Battery acid cleanup. Battery acid can cause severe injury or death. Battery acid is electrically conductive and corrosive. Add 500 g (1 lb.) of bicarbonate of soda (baking soda) to a container with 4 L (1 gal.) of water and mix the neutralizing solution. Pour the neutralizing solution on the spilled battery acid and continue to add the neutralizing solution to the spilled battery acid until all evidence of a chemical reaction (foaming) has ceased. Flush the resulting liquid with water and dry the area.

Battery gases. Explosion can cause severe injury or death. Battery gases can cause an explosion. Do not smoke or permit flames or sparks to occur near a battery at any time, particularly when it is charging. Do not dispose of a battery in a fire. To prevent burns and sparks that could cause an explosion, avoid touching the battery terminals with tools or other metal objects. Remove all jewelry before servicing the equipment. Discharge static electricity from your body before touching batteries by first touching a grounded metal surface away from the battery. To avoid sparks, do not disturb the battery charger connections while the battery is charging. Always turn the battery charger off before disconnecting the battery connections. Ventilate the compartments containing batteries to prevent accumulation of explosive gases.

Battery short circuits. Explosion can cause severe injury or death. Short circuits can cause bodily injury and/or equipment damage. Disconnect the battery before maintenance. Remove all jewelry before servicing the equipment. Use tools with insulated handles. Remove the negative (–) lead first when disconnecting the battery. Reconnect the negative (–) lead last when reconnecting the battery. Never connect the negative (–) battery cable to the positive (+) connection terminal of the starter solenoid. Do not test the battery condition by shorting the terminals together.



Check the condition of the battery and connections according to the intervals specified in “Periodic Maintenance Schedule.” Specific items to look for are:

- Loose or missing fasteners on the battery hold-down.
- Loose cable connections.
- Frayed, cut, or broken cables.
- Cracks in battery cell cover or case.
- Dirt, oil, or water contamination.
- Corrosion at battery terminals.
- Reduction in voltage or ability to hold a charge.



Repair or replace the battery and/or components as needed. Use only replacement parts that are equivalent to the original equipment. Contact your Kohler authorized distributor/dealer for assistance.

3.6.2 Check and Adjust the Drive Belt

A worn, stretched, or damaged drive belt may fail, especially under heavy loads. Check the condition of the drive belt regularly and adjust belt tension as needed.

 WARNING	Accidental starting. Can cause severe injury or death.
	Disconnect the battery cables before working on the engine. Remove the negative (-) lead first when disconnecting the battery. Reconnect the negative (-) lead last when reconnecting the battery.

Disabling the engine. Accidental starting can cause severe injury or death. Before working on the engine or connected equipment, disable the engine as follows: 1) Disconnect the ignition coil. 2) Remove the battery cables, negative (-) lead first. Reconnect the negative (-) lead last when reconnecting the battery. Follow these precautions to prevent the accidental starting of the engine.

 WARNING	Moving parts. Can cause severe injury or death.
	Operate the engine only when all guards and electrical enclosures are in place. Stay away from moving parts while the engine is in operation.

Servicing the engine when it is operating. Exposed moving parts can cause severe injury or death. Keep hands, feet, hair, clothing, and test leads away from the belts and pulleys when the engine is running. Replace guards, screens, and covers before operating the engine.

Check drive belt condition:

1. Stop the engine and allow it to cool.
2. Locate the drive belt. See Figure 29.

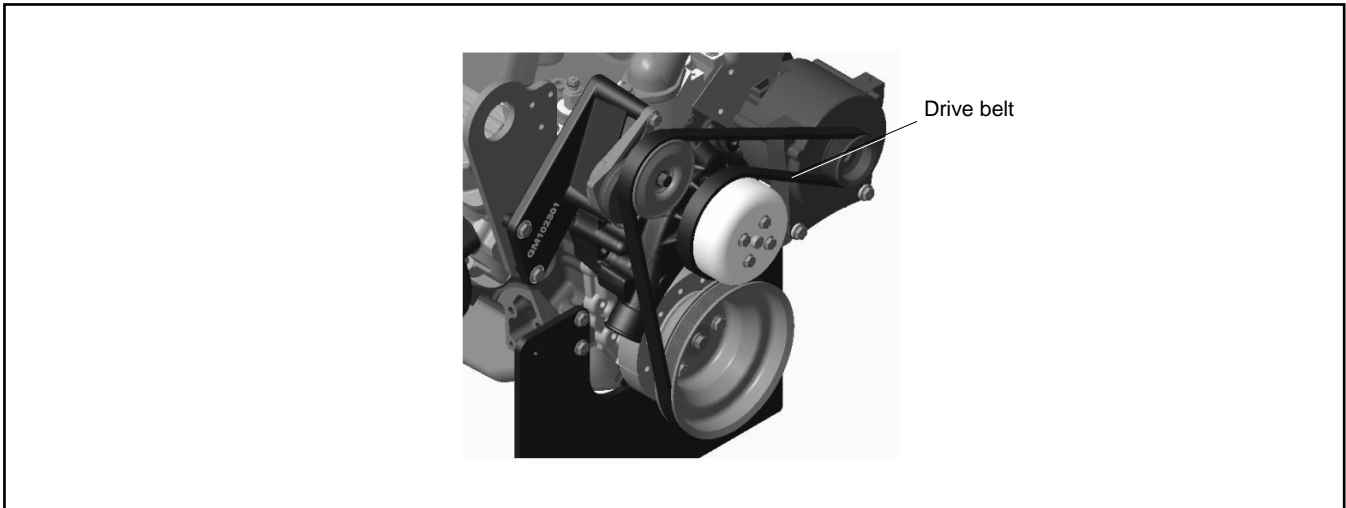

Figure 29 Drive Belt Location

3. Inspect the drive belt. Look for signs of cracking, separation, cuts, or other damage. See Figure 30.
4. If any abnormality is found, replace the drive belt.

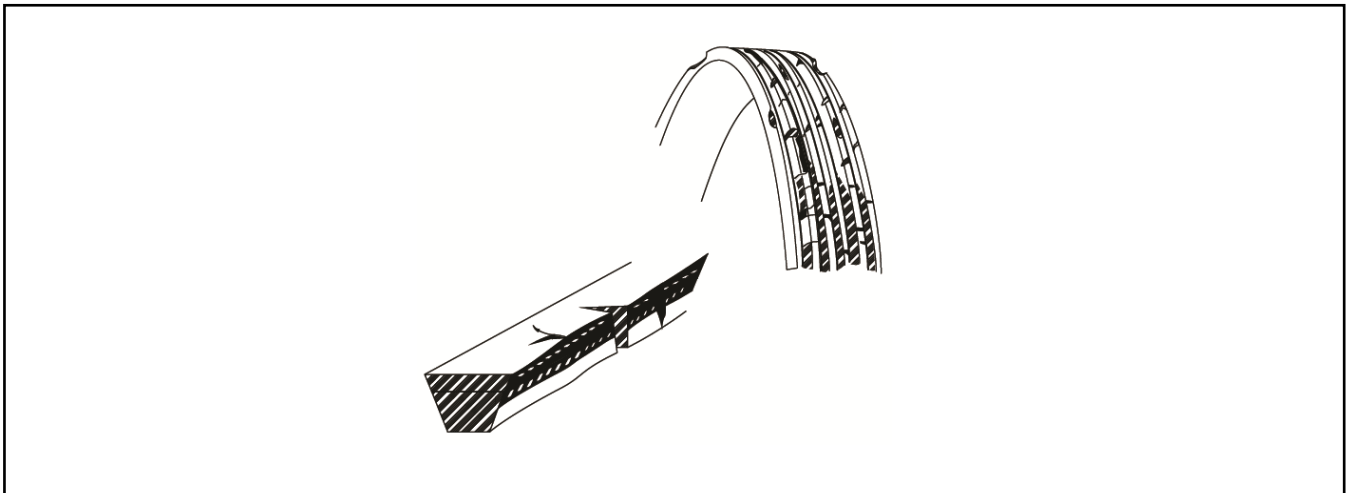



Figure 30 Drive Belt Damage

3.6.3 Replace the Drive Belt

⚠ WARNING	Accidental starting. Can cause severe injury or death.
	Disconnect the battery cables before working on the engine. Remove the negative (-) lead first when disconnecting the battery. Reconnect the negative (-) lead last when reconnecting the battery.

Disabling the engine. Accidental starting can cause severe injury or death. Before working on the engine or connected equipment, disable the engine as follows: 1) Disconnect the ignition coil. 2) Remove the battery cables, negative (-) lead first. Reconnect the negative (-) lead last when reconnecting the battery. Follow these precautions to prevent the accidental starting of the engine.

⚠ WARNING	Moving parts. Can cause severe injury or death.
	Operate the engine only when all guards and electrical enclosures are in place. Stay away from moving parts while the engine is in operation.

Servicing the engine when it is operating. Exposed moving parts can cause severe injury or death. Keep hands, feet, hair, clothing, and test leads away from the belts and pulleys when the engine is running. Replace guards, screens, and covers before operating the engine.

Required materials:

- Replacement drive belt.
- 14 mm socket and wrench

NOTICE
Do not replace a drive belt with one that is old or worn. An old or worn replacement may not last as long as a new drive belt and may not hold consistent tension, especially under load.

Procedure

1. Use a socket wrench to turn the tensioner pulley clockwise against the spring force. See Figure 31.

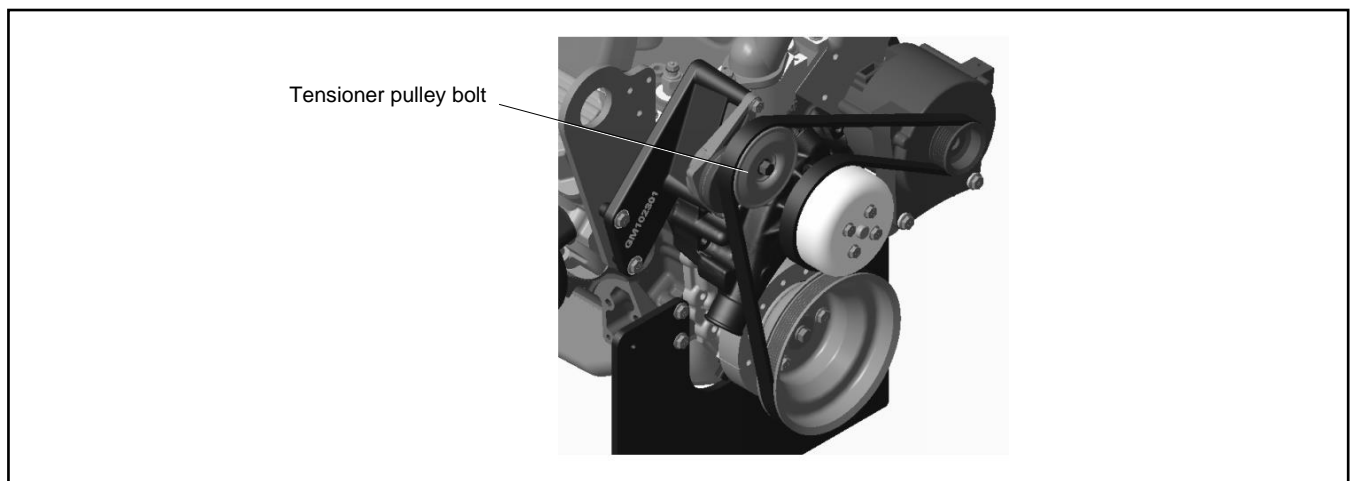

Figure 31 Tensioner Location

2. With the tensioner pulley disengaged, remove and discard the drive belt and then release the tensioner.
3. Route a new drive belt following the diagram shown in Figure 32.

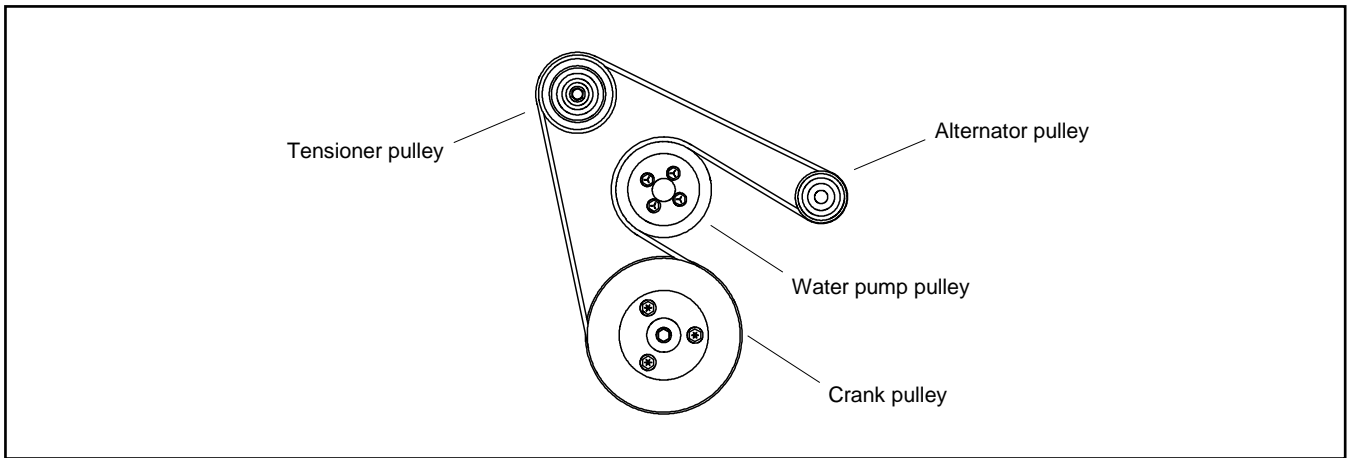

Figure 32 Drive Belt Diagram

4. While using the socket wrench to turn the tensioner pulley clockwise, slip the belt around the tensioner pulley. Release the tensioner.
5. Make sure that the belt is properly aligned with the grooves on each pulley. See Figure 33.

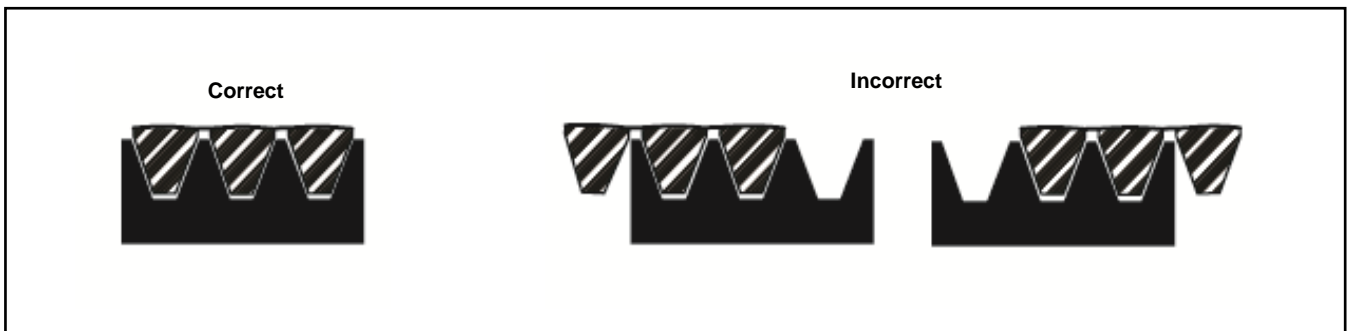



Figure 33 Belt Alignment

3.6.4 Check Wiring and Electrical Connections



 CAUTION	<p>Hazardous voltage. Electrical shock can cause injury.</p> <p>Do not touch wires while the engine is running. Stop the engine and disconnect the battery leads, negative (-) lead first, before servicing the engine.</p>
	

Check the condition of the wiring and electrical connections after every 10 hours of operation. Specific items to look for are:

- Exposed (bare) wires.
- Cuts or abrasions in wire insulation.
- Loose connections at screw terminals.
- Loose, dirty, or cracked electrical connectors.
- Melted or scorched wiring, insulation, or connectors.

Repair or replace faulty electrical components before operating the machine.

3.7 Cooling System

 WARNING	<p>Hot coolant and steam. Can cause severe injury or death.</p> <p>Before removing the pressure cap, stop the engine and allow it to cool. Then loosen the pressure cap to relieve pressure.</p>
	

The engine is equipped with a unit-mounted radiator common cooling system. Add coolant before starting the engine.

The system's major components include either two electric fans or an engine-mounted fan (depending on the application), a circulating water pump, a radiator, and a thermostat. The pump circulates water through the engine until it reaches operating temperature. Then the engine thermostat opens, allowing water circulation through the radiator. The thermostat restricts water flow as necessary to prevent overcooling. The fans blow air through the radiator across the cooling surface.

On turbocharged models, KG6208TA, an oil cooler provides additional cooling and is located on the side of the radiator next to the charge air cooler. The oil pump circulates oil through the engine until it reaches operating temperature. When the oil reaches operating temperature, the oil cooler thermostat opens, allowing oil to circulate through the oil cooler. The thermostat restricts oil as necessary to prevent overcooling. As engine oil passes through the oil cooler, fans blow air through the oil cooler across the cooling surface.

Some engines are equipped with an optional block heater.

Note:

Block Heater Damage. The block heater will fail if the energized heater element is not immersed in coolant. Fill the cooling system before turning on the block heater. Run the engine until it is warm and refill the radiator to purge the air from the system before energizing the block heater.

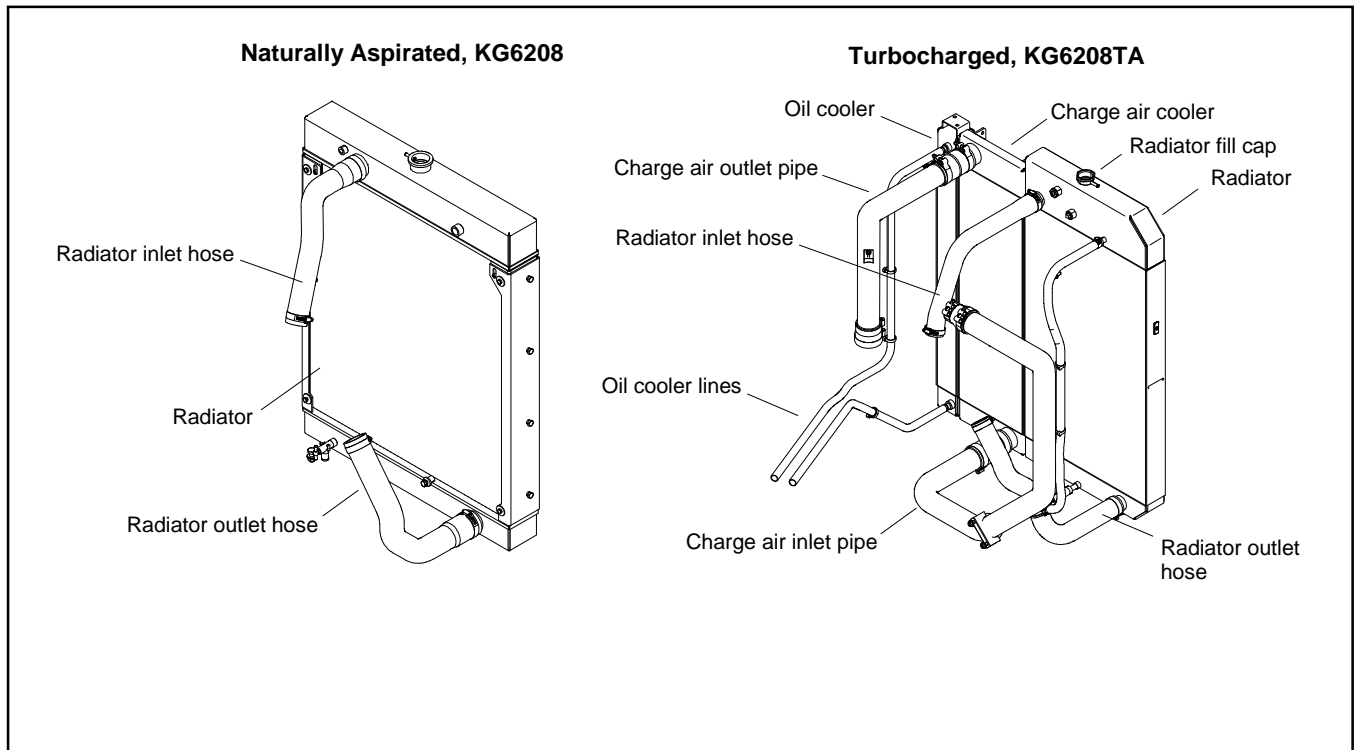

Figure 34 Cooling Systems, Naturally Aspirated and Turbocharged

3.7.1 Check Coolant Level and Condition

The engine coolant level should be checked daily before starting the engine. Insufficient coolant will cause the engine to overheat.

1. Open the radiator cap slowly in order to release the pressure in the system.
2. Maintain the coolant level in the coolant overflow bottle between the High and Low markings. See “Coolant Recommendations.”

Note:

Periodically check the coolant level by removing the radiator’s pressure cap. Do not rely solely on the level in the coolant overflow bottle.

3. Install and tighten the radiator cap.

Check coolant condition:

Engine coolant should be uniformly colored and transparent. Replace the coolant if it is dirty, discolored, or fouled with oil or rust particles.

Rusty coolant may indicate corrosion inside the radiator. Oil in the coolant indicates a leak somewhere in the lubrication system. Contact a Kohler authorized distributor/dealer if either of these conditions exist.

3.7.2 Check Hoses and Clamps

Check the condition of the coolant system hoses and clamps every 10 hours of operation.

Hoses:

- Inspect the hoses for cracks, abrasions, cuts, bulges, swollen ends, or leaks.
- Squeeze the hoses. They should yield slightly to moderate pressure and not feel too hard, too soft, or spongy.
- Replace faulty hoses before operating the engine.



Clamps:

- Verify that all clamps are in place.
- Adjust and tighten clamps as needed.

3.7.3 Draining and Replacing the Coolant

There are no coolant plugs or drainage valves on the engine. To drain and replace the coolant, refer to the radiator procedures in the Operation Manual for the equipment using this engine.

3.8 Fuel System

 WARNING	Explosive fuel vapors. Can cause severe injury or death. Use extreme care when handling, storing, and using fuels.
	

The fuel system. Explosive fuel vapors can cause severe injury or death. Vaporized fuels are highly explosive. Use extreme care when handling and storing fuels. Store fuels in a well-ventilated area away from spark-producing equipment and out of the reach of children. Never add fuel to the tank while the engine is running because spilled fuel may ignite on contact with hot parts or from sparks. Do not smoke or permit flames or sparks to occur near sources of spilled fuel or fuel vapors. Keep the fuel lines and connections tight and in good condition. Do not replace flexible fuel lines with rigid lines. Use flexible sections to avoid fuel line breakage caused by vibration. Do not operate the engine in the presence of fuel leaks, fuel accumulation, or sparks. Repair fuel systems before resuming engine operation.

Gas fuel leaks. Explosive fuel vapors can cause severe injury or death. Fuel leakage can cause an explosion. Check the LPG vapor or natural gas fuel system for leakage by using a soap and water solution with the fuel system test pressurized to 6–8 ounces per square inch (10–14 inches water column). Do not use a soap solution containing either ammonia or chlorine because both prevent bubble formation. A successful test depends on the ability of the solution to bubble.

Note:

Fuel system components are not adjustable and cannot be serviced. Contact your authorized KOHLER authorized distributor/dealer for replacements.

3.8.1 Check Fuel Supply Pipe and Connections

With the fuel valve fully opened and the engine stopped, check all fuel system connections and lines for leaks using a soapy water solution. Correct any leaks before restarting the engine. **Do not start the engine if you can smell leaking gas.** Have any necessary service performed by a Kohler authorized distributor/dealer.

3.8.2 Check Fuel Level (LPG only)

With the fuel valve on the LPG tank fully closed and the engine stopped, check the fuel gauge on the LPG tank. Make sure that the tank contains enough fuel for sustained operation. If not, refill the tank before restarting the engine.

Fully open the fuel valve on the LPG tank. Check all fuel supply connections and lines for leaks using a soapy water solution. Correct any leaks before restarting the engine. Have any necessary service performed by a Kohler authorized distributor/dealer or qualified LPG/NG technician only.

Section 4. Troubleshooting

4.1 Introduction

The following chart will help you to identify and solve some of the basic operating problems that may occur while operating this engine.









Do not attempt to service or replace major engine components, or any items that require special timing or adjustment procedures. This work should be performed only by a Kohler authorized distributor/dealer.

4.2 Troubleshooting

Problem	Possible Cause	Solution
Will Not Start	No fuel	Check fuel supply.
	Incorrect fuel	Make sure fuel system is configured properly for LPG or NG supply.
	Dirty/restricted fuel system	Check fuel system and clean components as needed.
	Incorrect oil level	Check engine oil level; add as needed.
	Engine overloaded	Disconnect or reduce loads.
	Faulty spark plug, wire, or ignition coil	Inspect, adjust, or replace as needed.
	Dirty/restricted air cleaner element	Clean or replace.
	Exhaust restricted	Check for exhaust obstructions.
Hard Starting	No fuel	Check fuel supply.
	Incorrect fuel	Make sure fuel system is configured properly for LPG or NG supply.
	Restricted fuel flow	Make sure fuel supply valves are open; check for air intake system leakage.
	Dirty/restricted fuel system	Check fuel system and clean components as needed.
	Incorrect oil level	Check engine oil level; add as needed.
	Engine overloaded	Disconnect or reduce loads.
	Faulty spark plug, wire, or ignition coil	Inspect, adjust, or replace as needed.
	Dirty/restricted air cleaner element	Clean or replace.
Exhaust restricted	Check for exhaust obstructions.	
Stops Suddenly	No fuel	Check fuel supply.
	Dirty/restricted fuel system	Check fuel system and clean components as needed.
	Incorrect oil level	Check engine oil level; add as needed.
	Engine overloaded	Disconnect or reduce loads.
	Dirty/restricted air cleaner element	Clean or replace.
	Exhaust restricted	Check for exhaust obstructions.
Lacks Power	Incorrect fuel	Make sure fuel system is configured properly for LPG or NG supply.
	Low fuel pressure	Check and adjust fuel pressure.
	Incorrect oil level	Check engine oil level; add as needed.
	Engine overloaded	Disconnect or reduce loads.
	Faulty spark plug, wire, or ignition coil	Inspect, adjust, or replace as needed.
	Dirty/restricted fuel system	Check fuel system and clean components as needed.
	Air induction system leak	Inspect air induction system.
	Damaged turbocharger (If applicable)	Inspect turbocharger compressor and turbine blades for damage and/or contact against housing.

Problem	Possible Cause	Solution
Operates Erratically or Unevenly	Incorrect fuel	Make sure fuel system is configured properly for LPG or NG supply.
	Dirty/restricted fuel system	Check fuel system and clean components as needed.
	Low fuel supply pressure	Check and adjust.
	Engine overloaded	Disconnect or reduce loads.
	Loose wiring at shut-off valve(s)	Check wiring and repair connections.
	Faulty spark plug, wire, or ignition coil	Inspect, adjust, or replace as needed.
	Dirty air filter	Inspect and replace as needed.
Knocks or Pings	Incorrect fuel	Make sure fuel system is configured properly for LPG or NG supply.
	Engine overloaded	Disconnect or reduce loads.
	Faulty spark plug, wire, or ignition coil	Inspect, adjust, or replace as needed.
	Dirty/restricted fuel system	Check fuel system and clean components as needed.
	Dirty air filter	Inspect and replace as needed.
	Boost pressure too high (if applicable)	Check for stuck wastegate, check for leak in wastegate boost line (if applicable).
	Excessive intake manifold temperature	Check charge air cooler for debris and clean as needed (if applicable).
Skips or Misfires	Incorrect fuel	Make sure fuel system is configured properly for LPG or NG supply.
	Faulty spark plug, wire, or ignition coil	Inspect, adjust, or replace as needed.
	Dirty/restricted fuel system	Check fuel system and clean components as needed.
	Dirty air filter	Inspect and replace as needed.
Backfires	Incorrect fuel	Make sure fuel system is configured properly for LPG or NG supply.
	Faulty spark plug, wire, or ignition coil	Inspect, adjust, or replace as needed.
	Dirty/restricted fuel system	Check fuel system and clean components as needed.
	Dirty air filter	Inspect and replace as needed.
Overheats	Incorrect fuel	Make sure fuel system is configured properly for LPG or NG supply.
	Dirty/restricted fuel system	Check fuel system and clean components as needed.
	Incorrect oil level	Check engine oil level; add as needed.
	Engine overloaded	Disconnect or reduce loads.
	Faulty spark plug, wire, or ignition coil	Inspect, adjust, or replace as needed.
	Faulty engine coolant temperature sender	Inspect the engine coolant temperature sender and wires and replace or repair as needed.
Consumes Excess Fuel	Faulty spark plug, wire, or ignition coil	Inspect, adjust, or replace as needed.
	Dirty/restricted air cleaner element	Clean or replace.
	Incorrect fuel pressure	Check and adjust fuel pressure.
ECM Does Not Store DTC	Faulty electrical connections, components, or wiring	Contact an authorized Kohler distributor/dealer.
Erratic operation	Air induction system leak	Inspect air induction system.

Section 5. Storage

 WARNING	Hot engine and exhaust system. Can cause severe injury or death. Do not work on the engine until it cools.
	
 WARNING	Moving parts. Can cause severe injury or death. Operate the engine only when all guards and electrical enclosures are in place. Stay away from moving parts while the engine is in operation.
	
 CAUTION	Hazardous voltage. Electrical shock can cause injury. Do not touch wires while the engine is running. Stop the engine and disconnect the battery leads, negative (-) lead first, before servicing the engine.
	
 WARNING	Handling caustic engine fluids and chemical products. Can cause severe chemical burns, nausea, fainting, or death. Most chemicals such as used engine oil, antifreeze/coolant, rustproofing agent, inhibiting oil, degreasing agent, spray paint, and adhesives are hazardous to health. Read and follow the user information found on the packaging. Avoid inhalation and skin contact. Use only in well-ventilated areas and use a protective mask when spraying. Store engine fluids and chemical products in a locked cabinet. Contact your local recycling center for disposal information and locations.
	

5.1 Preparation

If you plan to take the engine out of service for an extended period of time, prepare the engine according to the procedures described in this section. These preventive measures will help to protect your engine from the cumulative effects of rust and deterioration while it is not being used.

- Perform scheduled periodic maintenance tasks.
- Make all necessary repairs and adjustments.
- Close the fuel valves and disconnect the fuel supply.
- Clean the outside of the engine. Wipe away all visible dirt, dust, and oil.
- Remove the starting key.

5.2 Short-Term Storage (Less than 30 Days)

- Disconnect and remove the battery.
- Cover or cap all intake and exhaust ports, including fuel lines, air filter, and engine exhaust.
- Cover the engine with a clean, dry cloth.
- Store the engine in a secure, dry location away from trespassers, children, and animals.

5.3 Long-Term Storage (More than 30 Days)

In addition to the short-term tasks, perform the following tasks before placing the engine in storage:

- Change the engine oil and filter.
- Remove the drive belt.
- Protect the cylinders from rust:
 - Disconnect the spark plug wires and remove the spark plugs.
 - Squirt approximately 30 ml (1 ounce) of fresh engine oil into each cylinder.
 - Manually rotate the crankshaft 10–15 times to distribute the oil evenly in the cylinders.
 - Install the spark plugs and reconnect the spark plug wires.
- Cover all exposed metal parts with a suitable protectant.
- Coat all electrical connectors with a suitable protectant.

5.4 Maintenance while in Storage

- Inspect the engine regularly (at least once a month). Check for signs of rust or leaks.
- Periodically test the battery voltage and recharge as needed. The battery may lose charge even when disconnected.

5.5 Removal from Storage

- Remove protective cloths, covers, and caps from the engine.
- Clean protectant from exposed metal parts and electrical components.
- Reinstall the drive belt.
- Check fluid levels and fill as needed.
- Connect the battery.
- Connect the fuel supply and open fuel valves.
- Start the engine and allow it to run for several minutes without load. Check for leaks and watch for signs of abnormal operation.

NOTE:

The engine may smoke when started for the first time after being taken out of storage. This is normal and occurs as the engine burns away the protective oil coating inside the cylinders.

- Check oil pressure and fuel pressure gauges to make sure that the engine is operating normally.

Section 6. Specifications

6.1 Engine Specifications

Item	Specifications	
Engine Model	KG6208	KG6208TA
Block Type	V-8	
Number of Cylinders	8	
Cylinder Bore	101.6 mm (4 in.)	
Piston Stroke	95.25 mm (3.75 in.)	
Displacement	6.2 L (377 in. ³)	
Rated Output @ 1800 rpm	75.0 kW (100.6 hp), NG 77.0 kW (103.3 hp), LPG	KG6208TASD Standard Duty
		93.6 kW (126 hp), NG 94.6 kW (127 hp), LPG
		KG6208TAHD Heavy Duty
		150 kW (201 hp), NG 129 kW (173 hp), LPG
Fuel Type	Propane, Liquid Petroleum Gas (LPG) or Natural Gas (NG). See "Fuel Specifications."	
Oil Type / Weight	See "Oil Recommendations" in the Maintenance section.	
Oil Dry Fill Capacity	5.7 L (6.0 qt.)	5.7 L (6.0 qt.)
Rotating Direction of Crankshaft	Counterclockwise (face to flywheel)	
Compression Ratio	10.5:1	9.8:1
Cylinder Fire Order	1-8-4-3-6-5-7-2	
Lubricating Style	Pressurized	
Starting Style	Electric	
Net Weight (Dry)	267.4 kg (589.5 lb.)	308.4 kg (680 lb.)
Overall Dimensions	728 mm x 665 mm x 680 mm (28.7 in. x 26.2 in. x 26.8 in.)	
Aspiration	Natural	Turbocharged
Charge Air Cooler	Not Applicable	Aluminum Core

6.2 Main Components Specifications

Item	Specifications	
	KG6208	KG6208TA
Oil Pump	Gear type	
Water Pump	Centrifugal type; no fan	
Flywheel	Flywheel with attachment provisions for flywheel adapter	
Thermostat Settings, Fully Open at	71°C (160°F)	
Alternator	Rated voltage 14 V, rated current 130 A	
Electric Starter	1.2 kW, speed reduction type	
Ignition System	Distributor	Ignition Coil Pack
Spark Plug (use only genuine Kohler service parts)	GM101273	GM104391
Crankcase Ventilation	Closed crankcase ventilation	

6.3 Adjustment Specifications

Item	Specifications	
	KG6208	KG6208TA
Spark Plug Gap, mm (in.)	0.76 (0.030)	0.4 (0.0157)
Direct Acting Electronic Pressure Regulator (DEPR)	Nonadjustable	
Throttle	Nonadjustable, ECM controlled	
Air–Fuel Mixer	Tamper-proof; nonadjustable	

6.4 Torque Specifications

Item	Torque
Spark Plugs – KG6208, KG6208TA, Nm (ft. lb.)	27 (20)

6.5 Standard Torque Specifications

American Standard Fasteners Torque Specifications						
Size	Torque Measurement	Assembled into Cast Iron or Steel			Assembled into Aluminum Grade 2 or 5	
		Grade 2	Grade 5	Grade 8		
8-32	Nm (in. lb.)	1.8 (16)	2.3 (20)	-	See Note 3	
10-24	Nm (in. lb.)	2.9 (26)	3.6 (32)	-		
10-32	Nm (in. lb.)	2.9 (26)	3.6 (32)	-		
1/4-20	Nm (in. lb.)	6.8 (60)	10.8 (96)	14.9 (132)		
1/4-28	Nm (in. lb.)	8.1 (72)	12.2 (108)	16.3 (144)		
5/16-18	Nm (in. lb.)	13.6 (120)	21.7 (192)	29.8 (264)		
5/16-24	Nm (in. lb.)	14.9 (132)	23.1 (204)	32.5 (288)		
3/8-16	Nm (ft. lb.)	24.0 (18)	38.0 (28)	53.0 (39)		
3/8-24	Nm (ft. lb.)	27.0 (20)	42.0 (31)	60.0 (44)		
7/16-14	Nm (ft. lb.)	39.0 (29)	60.0 (44)	85.0 (63)		
7/16-20	Nm (ft. lb.)	43.0 (32)	68.0 (50)	95.0 (70)		
1/2-13	Nm (ft. lb.)	60.0 (44)	92.0 (68)	130.0 (96)		
1/2-20	Nm (ft. lb.)	66.0 (49)	103.0 (76)	146.0 (108)		
9/16-12	Nm (ft. lb.)	81.0 (60)	133.0 (98)	187.0 (138)		
9/16-18	Nm (ft. lb.)	91.0 (67)	148.0 (109)	209.0 (154)		
5/8-11	Nm (ft. lb.)	113.0 (83)	183.0 (135)	259.0 (191)		
5/8-18	Nm (ft. lb.)	128.0 (94)	208.0 (153)	293.0 (216)		
3/4-10	Nm (ft. lb.)	199.0 (147)	325.0 (240)	458.0 (338)		
3/4-16	Nm (ft. lb.)	222.0 (164)	363.0 (268)	513.0 (378)		
1-8	Nm (ft. lb.)	259.0 (191)	721.0 (532)	1109.0 (818)		
1-12	Nm (ft. lb.)	283.0 (209)	789.0 (582)	1214.0 (895)		
Metric Fasteners Torque Specifications						
Size	Torque Measurement	Assembled into Cast Iron or Steel				Assembled into Aluminum Grade 5.8 or 8.8
		Grade 5.8	Grade 8.8	Grade 10.9		
M6 x 1.00	Nm (ft. lb.)	6.2 (4.6)	12 (9)	13.6 (10)	See Note 3	
M8 x 1.25	Nm (ft. lb.)	15.0 (11)	29.6 (22)	33.0 (24)		
M8 x 1.00	Nm (ft. lb.)	16.0 (11)	24.0 (18)	34.0 (25)		
M10 x 1.50	Nm (ft. lb.)	30.0 (22)	52.5 (39)	65.0 (48)		
M10 x 1.25	Nm (ft. lb.)	31.0 (23)	47.0 (35)	68.0 (50)		
M12 x 1.75	Nm (ft. lb.)	53.0 (39)	80.0 (59)	115.0 (85)		
M12 x 1.50	Nm (ft. lb.)	56.0 (41)	85.0 (63)	122.0 (90)		
M14 x 2.00	Nm (ft. lb.)	83.0 (61)	135.0 (100)	180.0 (133)		
M14 x 1.50	Nm (ft. lb.)	87.0 (64)	133.0 (98)	190.0 (140)		
M16 x 2.00	Nm (ft. lb.)	127.0 (94)	194.0 (143)	278.0 (205)		
M16 x 1.50	Nm (ft. lb.)	132.0 (97)	201.0 (148)	287.0 (212)		
M18 x 2.50	Nm (ft. lb.)	179.0 (132)	273.0 (201)	390.0 (288)		
M18 x 1.50	Nm (ft. lb.)	189.0 (140)	289.0 (213)	413.0 (305)		

Note:

1. The torque values above are general guidelines. Always use the torque values specified in the service manuals and/or assembly drawings when they differ from above torque values.
2. The torque values above are based on new plated threads. Increase torque values by 15% if non-plated threads are used.
3. Hardware threaded into aluminum must have either two diameters of thread engagement or a 30% or more reduction in the torque to prevent stripped threads.
4. Torque values are calculated as equivalent stress loading on American hardware with an approximate preload of 90% of the yield strength and a friction coefficient of 0.125.

TP-7095 1/19d

© 2018 by Kohler Co. All rights reserved.

KOHLER®

KOHLER CO. Kohler, Wisconsin 53044
Phone 920-457-4441, Fax 920-459-1646
For the nearest sales/service outlet in the
US and Canada, phone 1-800-544-2444
KOHLERPower.com