

# Operation

## Residential/Commercial Generator Sets



Models:

**8/10/12RESV**

**8/10/12RESVL**

Controller:

**RDC2**

**KOHLER®**

TP-6880 12/18d



# Table of Contents

<b>Product Identification Information</b> .....	<b>2</b>
<b>Safety Precautions and Instructions</b> .....	<b>5</b>
<b>Introduction</b> .....	<b>9</b>
<b>Service Assistance</b> .....	<b>11</b>
<b>Section 1 Descriptions and Service Views</b> .....	<b>13</b>
1.1 Introduction .....	13
1.2 Engine .....	13
1.3 Generator Set Enclosure .....	13
1.4 Alternator .....	13
1.5 Transfer Switch .....	13
1.6 Controllers .....	13
1.7 OnCue Plus Generator Management System .....	15
1.8 Accessories .....	15
1.8.1 Carburetor Heater .....	15
1.8.2 Programmable Interface Module (PIM) .....	15
1.8.3 Load Management .....	15
1.9 Service Views .....	16
<b>Section 2 Generator Set Operation</b> .....	<b>19</b>
2.1 Prestart Checklist .....	19
2.2 Exercising the Generator Set .....	21
2.3 Generator Set Operation .....	21
2.3.1 Local Starting and Stopping .....	21
2.3.2 Automatic Starting and Stopping .....	21
2.3.3 Remote Starting and Stopping .....	21
2.3.4 Engine Start Crank Cycle .....	21
2.3.5 Engine Cooldown .....	21
2.3.6 Automatic Operation with Model RXT Transfer Switch .....	21
2.3.7 Automatic Operation with Other Transfer Switches .....	22
2.4 Exercise .....	22
2.4.1 Setting the Exerciser .....	22
2.4.2 Unloaded Cycle Exercise with Complete System Diagnostics .....	22
2.4.3 Unloaded Full-Speed Exercise .....	23
2.4.4 Loaded Full-Speed Exercise (with RXT only) .....	23
2.4.5 Power Failure During Exercise Cycle .....	23
2.5 Faults .....	24
2.5.1 Warnings .....	24
2.5.2 Shutdowns .....	24
2.5.3 ATS Communication Errors .....	24
2.5.4 Resetting the Controller after a Fault Shutdown .....	24
2.6 Generator Enclosure Thermostat .....	27
<b>Section 3 RDC2 Controller Operation</b> .....	<b>29</b>
3.1 RDC2 Generator Set/ Transfer Switch Controller .....	29
3.2 Controls and Indicators .....	29
3.2.1 Controller Keypad .....	30
3.2.2 LED Indicators .....	30
3.2.3 LCD Display .....	31
3.3 Controller Power .....	32
3.4 Battery Charging .....	32
3.5 Changing Settings .....	32
3.6 Setting the Exerciser .....	34
3.6.1 Setting the Exerciser at Controller Power-up .....	34
3.6.2 Changing the Exercise Settings .....	34
3.7 RDC2 Controller Menus .....	36
3.8 Main Menu .....	36
3.9 Overview Menu .....	37
3.10 Engine Metering Menu .....	37
3.11 Generator Metering Menu .....	38
3.12 Generator Set Information Menu .....	39
3.13 Genset Run Time Menu .....	39
3.14 Genset System Menu .....	40

# Table of Contents, continued

---

3.15	ATS Status Menu .....	41
3.16	ATS Configuration Menu .....	42
3.17	Date and Time Menu .....	43
3.18	Networking Information Menus .....	43
3.18.1	Networking Status Submenu .....	44
3.18.2	Networking Configuration Submenu (OnCue Plus Password) .....	45
3.18.3	RBUS Information .....	47
3.18.4	Remote Devices Submenu .....	48
3.19	Programmable Interface Module (PIM) Status Menu .....	49
3.20	Load Control Menus .....	50
3.21	Event Log .....	51
<b>Section 4 Scheduled Maintenance .....</b>		<b>53</b>
4.1	Scheduled Maintenance .....	54
4.1.1	Service Schedule .....	55
4.2	Lubrication System .....	56
4.2.1	Low Oil Pressure Shutdown .....	56
4.2.2	Oil Check .....	56
4.2.3	Engine Oil Recommendation .....	56
4.2.4	Oil Change Procedure .....	56
4.2.5	Resetting the Maintenance Timer .....	58
4.3	Spark Plugs .....	58
4.4	Air Cleaner Service .....	59
4.4.1	Air Cleaner, 8RESV/RESVL Models .....	59
4.4.2	Air Cleaner, 10/12RESV/RESVL Models .....	60
4.5	Cooling System .....	60
4.6	Exhaust System .....	61
4.7	Battery .....	62
4.7.1	Checking Electrolyte Level .....	63
4.7.2	Checking Specific Gravity .....	63
4.8	Storage Procedure .....	64
4.8.1	Lubricating System .....	64
4.8.2	Fuel System .....	64
4.8.3	Cylinder Lubrication .....	64
4.8.4	Exterior Preparation .....	64
4.8.5	Battery .....	64
<b>Section 5 Troubleshooting .....</b>		<b>65</b>
5.1	Introduction .....	65
5.2	USB Port .....	65
5.3	Fault Messages .....	65
5.4	Circuit Protection .....	65
5.4.1	Controller Internal Circuit Protection .....	65
5.4.2	Line Circuit Breaker .....	65
5.4.3	Auxiliary Winding Circuit Breaker .....	65
5.5	Troubleshooting .....	66
<b>Appendix A Abbreviations .....</b>		<b>67</b>
<b>Appendix B DC2 Controller Operation .....</b>		<b>69</b>

# Safety Precautions and Instructions

IMPORTANT SAFETY INSTRUCTIONS. Electromechanical equipment, including generator sets, transfer switches, switchgear, and accessories, can cause bodily harm and pose life-threatening danger when improperly installed, operated, or maintained. To prevent accidents be aware of potential dangers and act safely. Read and follow all safety precautions and instructions. **SAVE THESE INSTRUCTIONS.**

This manual has several types of safety precautions and instructions: Danger, Warning, Caution, and Notice.

## DANGER

Danger indicates the presence of a hazard that **will cause severe personal injury, death, or substantial property damage.**

## WARNING

Warning indicates the presence of a hazard that **can cause severe personal injury, death, or substantial property damage.**

## CAUTION


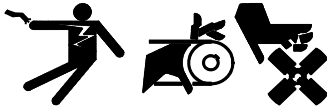
Caution indicates the presence of a hazard that **will or can cause minor personal injury or property damage.**

## NOTICE

Notice communicates installation, operation, or maintenance information that is safety related but not hazard related.



Safety decals affixed to the equipment in prominent places alert the operator or service technician to potential hazards and explain how to act safely. The decals are shown throughout this publication to improve operator recognition. Replace missing or damaged decals.



## Accidental Starting

 <b>WARNING</b>

<b>Accidental starting. Can cause severe injury or death.</b>
Disconnect the battery cables before working on the generator set. Remove the negative (-) lead first when disconnecting the battery. Reconnect the negative (-) lead last when reconnecting the battery.

**Disabling the generator set. Accidental starting can cause severe injury or death.** Before working on the generator set or equipment connected to the set, disable the generator set as follows: (1) Press the generator set off/reset button to shut down the generator set. (2) Disconnect the power to the battery charger, if equipped. (3) Remove the battery cables, negative (-) lead first. Reconnect the negative (-) lead last when reconnecting the battery. Follow these precautions to prevent the starting of the generator set by the remote start/stop switch.

## Battery

 <b>WARNING</b>

<b>Sulfuric acid in batteries. Can cause severe injury or death.</b>
Wear protective goggles and clothing. Battery acid may cause blindness and burn skin.

 <b>WARNING</b>

<b>Explosion. Can cause severe injury or death. Relays in the battery charger cause arcs or sparks.</b>
Locate the battery in a well-ventilated area. Isolate the battery charger from explosive fumes.


**Battery electrolyte is a diluted sulfuric acid. Battery acid can cause severe injury or death.** Battery acid can cause blindness and burn skin. Always wear splashproof safety goggles, rubber gloves, and boots when servicing the battery. Do not open a sealed battery or mutilate the battery case. If battery acid splashes in the eyes or on the skin, immediately flush the affected area for 15 minutes with large quantities of clean water. Seek immediate medical aid in the case of eye contact. Never add acid to a battery after placing the battery in service, as this may result in hazardous spattering of battery acid.

**Battery acid cleanup. Battery acid can cause severe injury or death.** Battery acid is electrically conductive and corrosive. Add 500 g (1 lb.) of bicarbonate of soda (baking soda) to a container with 4 L (1 gal.) of water and mix the neutralizing solution. Pour the neutralizing solution on the spilled battery acid and continue to add the neutralizing solution to the spilled battery acid until all evidence of a chemical reaction (foaming) has ceased. Flush the resulting liquid with water and dry the area.

**Battery gases. Explosion can cause severe injury or death.** Battery gases can cause an explosion. Do not smoke or permit flames or sparks to occur near a battery at any time, particularly when it is charging. Do not dispose of a battery in a fire. To prevent burns and sparks that could cause an explosion, avoid touching the battery terminals with tools or other metal objects. Remove all jewelry before servicing the equipment. Discharge static electricity from your body before touching batteries by first touching a grounded metal surface away from the battery. To avoid sparks, do not disturb the battery charger connections while the battery is charging. Always turn the battery charger off before disconnecting the battery connections. Ventilate the compartments containing batteries to prevent accumulation of explosive gases.

**Battery short circuits. Explosion can cause severe injury or death.** Short circuits can cause bodily injury and/or equipment damage. Disconnect the battery before generator set installation or maintenance. Remove all jewelry before servicing the equipment. Use tools with insulated handles. Remove the negative (-) lead first when disconnecting the battery. Reconnect the negative (-) lead last when reconnecting the battery. Never connect the negative (-) battery cable to the positive (+) connection terminal of the starter solenoid. Do not test the battery condition by shorting the terminals together.

## Engine Backfire/Flash Fire

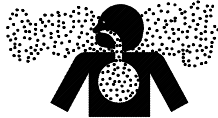
<b>⚠ WARNING</b>

<p><b>Risk of fire.</b>  <b>Can cause severe injury or death.</b></p> <p>Do not smoke or permit flames or sparks near fuels or the fuel system.</p>

**Servicing the air cleaner. A sudden backfire can cause severe injury or death.** Do not operate the generator set with the air cleaner removed.

**Servicing the fuel system. A flash fire can cause severe injury or death.** Do not smoke or permit flames or sparks near the carburetor, fuel line, fuel filter, fuel pump, or other potential sources of spilled fuels or fuel vapors. Catch fuels in an approved container when removing the fuel line or carburetor.

**Combustible materials. A fire can cause severe injury or death.** Generator set engine fuels and fuel vapors are flammable and explosive. Handle these materials carefully to minimize the risk of fire or explosion. Equip the compartment or nearby area with a fully charged fire extinguisher. Select a fire extinguisher rated ABC or BC for electrical fires or as recommended by the local fire code or an authorized agency. Train all personnel on fire extinguisher operation and fire prevention procedures.

## Exhaust System

<b>⚠ WARNING</b>

<p><b>Carbon monoxide.</b>  <b>Can cause severe nausea, fainting, or death.</b></p> <p>The exhaust system must be leakproof and routinely inspected.</p>

**Generator set operation. Carbon monoxide can cause severe nausea, fainting, or death.** Carbon monoxide is an odorless, colorless, tasteless, nonirritating gas that can cause death if inhaled for even a short time. Avoid breathing exhaust fumes when working on or near the generator set. Never operate the generator set inside a building. Never operate the generator set where exhaust gas could seep inside or be drawn into a potentially occupied building through windows, air intake vents, or other openings.

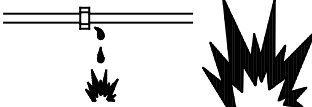
**Carbon monoxide detectors. Carbon monoxide can cause severe nausea, fainting, or death.** Install carbon monoxide detectors on each level of any building adjacent to the generator set. Locate the detectors to adequately warn the building's occupants of the presence of carbon monoxide. Keep the detectors operational at all times. Periodically test and replace the carbon monoxide detectors according to the manufacturer's instructions.

**Carbon monoxide symptoms. Carbon monoxide can cause severe nausea, fainting, or death.** Carbon monoxide is a poisonous gas present in exhaust gases. Carbon monoxide is an odorless, colorless, tasteless, nonirritating gas that can cause death if inhaled for even a short time. Carbon monoxide poisoning symptoms include but are not limited to the following:

- Light-headedness, dizziness
- Physical fatigue, weakness in joints and muscles
- Sleepiness, mental fatigue, inability to concentrate or speak clearly, blurred vision
- Stomachache, vomiting, nausea

If experiencing any of these symptoms and carbon monoxide poisoning is possible, seek fresh air immediately and remain active. Do not sit, lie down, or fall asleep. Alert others to the possibility of carbon monoxide poisoning. Seek medical attention if the condition of affected persons does not improve within minutes of breathing fresh air.


## Fuel System

<b>⚠ WARNING</b>

<p><b>Explosive fuel vapors. Can cause severe injury or death.</b></p> <p>Use extreme care when handling, storing, and using fuels.</p>

**The fuel system. Explosive fuel vapors can cause severe injury or death.** Vaporized fuels are highly explosive. Use extreme care when handling and storing fuels. Store fuels in a well-ventilated area away from spark-producing equipment and out of the reach of children. Never add fuel to the tank while the engine is running because spilled fuel may ignite on contact with hot parts or from sparks. Do not smoke or permit flames or sparks to occur near sources of spilled fuel or fuel vapors. Keep the fuel lines and connections tight and in good condition. Do not replace flexible fuel lines with rigid lines. Use flexible sections to avoid fuel line breakage caused by vibration. Do not operate the generator set in the presence of fuel leaks, fuel accumulation, or sparks. Repair fuel systems before resuming generator set operation.


**Gas fuel leaks. Explosive fuel vapors can cause severe injury or death.** Fuel leakage can cause an explosion. Check the LPG vapor or natural gas fuel system for leakage by using a soap and water solution with the fuel system test pressurized to 6-8 ounces per square inch (10-14 inches water column). Do not use a soap solution containing either ammonia or chlorine because both prevent bubble formation. A successful test depends on the ability of the solution to bubble.

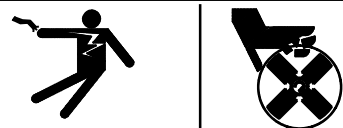
## Hazardous Noise


<b>⚠ CAUTION</b>

<p><b>Hazardous noise. Can cause hearing loss.</b></p> <p>Never operate the generator set without a muffler or with a faulty exhaust system.</p>


**Engine noise. Hazardous noise can cause hearing loss.** Generator sets not equipped with sound enclosures can produce noise levels greater than 105 dBA. Prolonged exposure to noise levels greater than 85 dBA can cause permanent hearing loss. Wear hearing protection when near an operating generator set.

## Hazardous Voltage/ Moving Parts

<b>⚠ DANGER</b>

<p><b>Hazardous voltage. Will cause severe injury or death.</b></p> <p>This equipment must be installed and serviced by qualified electrical personnel.</p>

<b>⚠ DANGER</b>

<p><b>Hazardous voltage. Moving parts. Will cause severe injury or death.</b></p> <p>Operate the generator set only when all guards and electrical enclosures are in place.</p>

<b>⚠ WARNING</b>

<p><b>Hazardous voltage. Backfeed to the utility system can cause property damage, severe injury, or death.</b></p> <p>If the generator set is used for standby power, install an automatic transfer switch to prevent inadvertent interconnection of standby and normal sources of supply.</p>

<b>⚠ CAUTION</b>

<p><b>Welding the generator set. Can cause severe electrical equipment damage.</b></p> <p>Never weld components of the generator set without first disconnecting the battery, controller wiring harness, and engine electronic control module (ECM).</p>

**Grounding electrical equipment. Hazardous voltage will cause severe injury or death.** Electrocutation is possible whenever electricity is present. Ensure you comply with all applicable codes and standards. Electrically ground the generator set, transfer switch, and related equipment and electrical circuits. Turn off the main circuit breakers of all power sources before servicing the equipment. Never contact electrical leads or appliances when standing in water or on wet ground because these conditions increase the risk of electrocution.


**Welding on the generator set. Can cause severe electrical equipment damage.** Before welding on the generator set perform the following steps: (1) Remove the battery cables, negative (-) lead first. (2) Disconnect all engine electronic control module (ECM) connectors. (3) Disconnect all generator set controller and voltage regulator circuit board connectors. (4) Disconnect the engine battery-charging alternator connections. (5) Attach the weld ground connection close to the weld location.

**Connecting the battery and the battery charger. Hazardous voltage will cause severe injury or death.** Reconnect the battery correctly, positive to positive and negative to negative, to avoid electrical shock and damage to the battery charger and battery(ies). Have a qualified electrician install the battery(ies).


**Short circuits. Hazardous voltage/current will cause severe injury or death.** Short circuits can cause bodily injury and/or equipment damage. Do not contact electrical connections with tools or jewelry while making adjustments or repairs. Remove all jewelry before servicing the equipment.

**Electrical backfeed to the utility. Hazardous backfeed voltage can cause severe injury or death.** Install a transfer switch in standby power installations to prevent the connection of standby and other sources of power. Electrical backfeed into a utility electrical system can cause severe injury or death to utility personnel working on power lines.

## Heavy Equipment

<b>⚠ WARNING</b>

<p><b>Unbalanced weight. Improper lifting can cause severe injury or death and equipment damage.</b></p> <p>Do not use lifting eyes. Lift the generator set using lifting bars inserted through the lifting holes on the skid.</p>

## Hot Parts

<b>⚠ WARNING</b>

<p><b>Hot engine and exhaust system. Can cause severe injury or death.</b></p> <p>Do not work on the generator set until it cools.</p>

**Servicing the exhaust system. Hot parts can cause severe injury or death.** Do not touch hot engine parts. The engine and exhaust system components become extremely hot during operation.

**Servicing the engine heater. Hot parts can cause minor personal injury or property damage.** Install the heater before connecting it to power. Operating the heater before installation can cause burns and component damage. Disconnect power to the heater and allow it to cool before servicing the heater or nearby parts.

## Notice

### NOTICE

**Canadian installations only.** For standby service connect the output of the generator set to a suitably rated transfer switch in accordance with Canadian Electrical Code, Part 1.



This manual provides operation and maintenance instructions for residential/commercial model 8/10/12RESV and RESVL generator sets equipped with Kohler RDC2 generator set/transfer switch controllers. See Figure 1. The RDC2 controllers control the generator set and the optional Model RXT transfer switch.

NOTE: The DC2 controller has been discontinued. Model 8/10/12RESV and RESVL generator sets built in 2019 are equipped with the RDC2 controller.

This generator set is approved for use in stationary applications in locations served by a reliable utility power source. Have the generator set installed by an authorized distributor/dealer or service technician. Refer to TP-6879, Installation Manual, for installation instructions.

Information in this publication represents data available at the time of print. Kohler Co. reserves the right to change this publication and the products represented without notice and without any obligation or liability whatsoever.

Read this manual and carefully follow all procedures and safety precautions to ensure proper equipment operation and to avoid bodily injury. Read and follow the Safety Precautions and Instructions section at the beginning of this manual. Keep this manual with the equipment for future reference.

The equipment service requirements are very important to safe and efficient operation. Inspect the parts often and perform required service at the prescribed intervals. Obtain service from an authorized service distributor/dealer to keep equipment in top condition.



**Figure 1** RESV/RESVL Generator Set

## List of Related Literature

Figure 2 identifies related literature available for the generator sets covered in this manual. Only trained and qualified personnel should install or service the generator set.

Generator Set Literature	Part Number
Spec Sheet, 8RESV (L)	G4-252
Spec Sheet, 10/12RESV(L)	G4-254
Installation Manual, Model 8/10/12RESV/RESVL Generator Set	TP-6984
<b>Transfer Switch Literature</b>	
Operation/Installation Manual, Model RXT Automatic Transfer Switch	TP-6807
Operation/Installation Manual, Model RDT Automatic Transfer Switch	TP-6345
<b>Accessory Literature</b>	
Installation/Technical Manual, OnCue® Plus Software	TP-7007
User Guide, OnCue® Plus Software	TP-7006
Operation Manual, SiteTech™ Software	TP-6701
Installation Instructions, Programmable Interface Module (PIM)	TT-1584
Instructions, Firmware Update Using USB Utility	TT-1636
Instructions, Load Shed Kit	TT-1609

**Figure 2** Related Literature

## Nameplate

The following illustration shows a typical generator set nameplate. Copy the model, serial, and specification numbers from the nameplate into the spaces provided in the product information section on the inside front cover of this manual. See the service views in Section 1.9 for the nameplate location.

## Emission Information

The Kohler® Model SV620 engine used on the 8RESV/RESVL generator set is certified to operate using natural gas or propane fuel.

The Kohler® Model KT725 engine used on the 10RESV/RESVL and 12RESV/RESVL generator set is certified to operate using natural gas or propane fuel.

The Emission Compliance Period referred to on the Emission Control or Air Index label indicates the number of operating hours for which the engine has been shown to meet CARB or EPA emission requirements. Figure 3 provides the engine compliance period (in hours) associated with the category descriptor, which may be found on the certification label.

Emission Compliance Period			
EPA	Category C 250 hours	Category B 500 hours	Category A 1000 hours
CARB	Moderate 125 hours	Intermediate 250 hours	Extended 500 hours

**Figure 3** Emission Compliance Period

Refer to the certification label for engine displacement.

The exhaust emission control system for the SV620 engines (8RESV/RESVL) is EM for U.S. EPA, California, and Europe.

The exhaust emission control system for the KT725 engine (10RESV/RESVL and 12RESV/RESVL) is EM for U.S. EPA, California, and Europe.

## Generator Set Application

Kohler® Power Systems (KPS) ensures that all Kohler® generator sets are certified to applicable standards for their intended application. It is the owner/operator's responsibility to operate Kohler® generator sets exclusively according to the directions provided in the accompanying operation manuals.

Kohler® generator sets designated as Stationary Standby, Emergency or Emergency Standby may only be operated for emergency power generation and for maintenance/testing. Emergency power generation is limited to power production when electric power from a local utility (or the normal power source, if the facility runs on its own power production) is interrupted.

The US Clean Air Act explicitly prohibits using Emergency Standby generators as a primary electric power source regardless of whether a site is connected to the electrical grid. Emergency Standby generators may NOT be used to power sites which are not connected to an electric utility. The U.S. Clean Air Act authorizes owner/operator fines of up to \$3,750 per day of operation in violation of the generator set's certification.

Owners/operators should familiarize themselves with and perform all testing, maintenance, notification, reporting and record keeping as required by the Clean Air Act. In most cases, performance testing is not required if the generator is operated and maintained according to the operation manual. However, owners/operators must retain maintenance records.

For professional advice on generator set power requirements and conscientious service, please contact your nearest Kohler distributor or dealer.

- Visit the Kohler Co. website at KOHLERPower.com.
- Look at the labels and decals on your Kohler product or review the appropriate literature or documents included with the product.
- Call toll free in the US and Canada 1-800-544-2444.
- Outside the US and Canada, call the nearest regional office.

## **Headquarters Europe, Middle East, Africa (EMEA)**

Kohler EMEA Headquarters

Netherlands B.V.

Kristallaan 1

4761 ZC Zevenbergen

The Netherlands

Phone: (31) 168 331630

Fax: (31) 168 331631

## **Asia Pacific**

Power Systems Asia Pacific Regional Office

Singapore, Republic of Singapore

Phone: (65) 6264-6422

Fax: (65) 6264-6455

## **China**

North China Regional Office, Beijing

Phone: (86) 10 6518 7950

(86) 10 6518 7951

(86) 10 6518 7952

Fax: (86) 10 6518 7955

East China Regional Office, Shanghai

Phone: (86) 21 6288 0500

Fax: (86) 21 6288 0550

## **India, Bangladesh, Sri Lanka**

India Regional Office

Bangalore, India

Phone: (91) 80 3366208

(91) 80 3366231

Fax: (91) 80 3315972

## **Japan, Korea**

North Asia Regional Office

Tokyo, Japan

Phone: (813) 3440-4515

Fax: (813) 3440-2727

# Notes

# Section 1 Descriptions and Service Views

## 1.1 Introduction

The generator set specification sheets provide specific generator and engine information. Refer to the spec sheet for data not supplied in this manual. Consult the generator set service manual, engine operation manual, and engine service manual for additional specifications. Obtain copies of the latest spec sheets, manuals, diagrams, and drawings from your local distributor/dealer.

## 1.2 Engine

The 8RESV generator set has a four-cycle, single cylinder, air-cooled Kohler® engine and 10/12RESV generator sets have a four-cycle, twin cylinder, air-cooled Kohler® engine. The engines operate on clean-burning natural gas or LPG. Engine features include:

- Efficient overhead valve design and full pressure lubrication for maximum power, torque, and reliability under all operating conditions.
- Dependable, maintenance-free electronic ignition.
- Precision-formulated cast iron construction of parts subjected to the most wear and tear.
- Field-convertible multi-fuel systems that allow fuel changeover from natural gas to LPG (and vice-versa) while maintaining EPA emission certification.

## 1.3 Generator Set Enclosure

The generator set is housed in a steel enclosure which is dipped in e-coat for extra corrosion protection and painted with a durable powder coat finish. The enclosure has a hinged, locking roof that allows easy access to the generator set controller when required, but locks securely to prevent unauthorized access.

To open the roof, insert the key provided with the enclosure and turn counterclockwise 1/4 turn. Then just raise the roof. The roof stays open until you are ready to close it.

Be sure to close and lock the enclosure, and keep the key in a secure location.

## 1.4 Alternator

The generator uses Kohler's unique PowerBoost™ voltage regulation system, which provides instant response to load changes.

PowerBoost™ ensures reliable motor starting and consistent voltage levels. PowerBoost™ utilizes a voltage excitation system that employs a winding independent of the main output windings to provide excitation voltage.

## 1.5 Transfer Switch

The RDC2 controller is designed to interface with and control the Kohler Model RXT Automatic Transfer Switch (ATS). Do not use the Kohler Model RRT transfer switch with the RDC2 controller.

If the power system uses a different model transfer switch, the RDC2 controllers will not control the transfer switch. An ATS other than the Model RXT must be equipped with a transfer switch controller and engine start contacts that connect to the remote engine start terminals on the generator set.

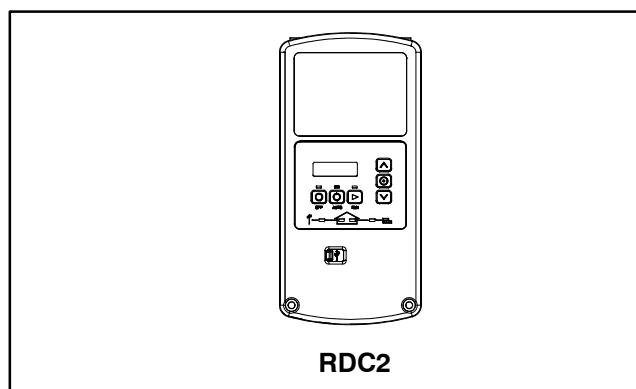
## 1.6 Controllers

The generator sets are equipped with the RDC2 controller. See Figure 1-1.

The controller provides integrated control for the generator set, Kohler® Model RXT transfer switch, programmable interface module (PIM), and load management device.

**Note:** Load management devices are not available with the transfer switch supplied with models 8RESVL, 10 RESVL, 12 RESVL.

The controller's 2-line LCD screen displays status messages and system settings that are clear and easy to read, even in direct sunlight or low light.



**Figure 1-1** Generator Set Controller

## RDC2 Controller Features

- Six-button keypad
  - OFF, AUTO, and RUN pushbuttons
  - Select and arrow buttons for access to system configuration and adjustment menus
- LED indicators for OFF, AUTO, and RUN modes
- LED indicators for utility power and generator set source availability and ATS position (Model RXT transfer switch required)
- LCD display
  - Two lines x 16 characters per line
  - Backlit display with adjustable contrast for excellent visibility in all lighting conditions
- Scrolling system status display
  - Generator set status
  - Voltage and frequency
  - Engine temperature
  - Oil pressure
  - Battery voltage
  - Engine runtime hours
- Date and time displays
- Smart engine cooldown senses engine temperature
- Digital isochronous governor to maintain steady-state speed at all loads
- Digital voltage regulation:  $\pm 0.5\%$  RMS no-load to full-load
- Automatic start with programmed cranking cycle
- Programmable exerciser can be set to start automatically on any future day and time, and run every week or every two weeks
- Exercise modes
  - Unloaded weekly exercise with complete system diagnostics
  - Unloaded full-speed exercise
  - Loaded full-speed exercise (Model RXT ATS required)
- Front-access mini USB connector for SiteTech™ connection or the Kohler USB utility
- Integral Ethernet connector for Kohler® OnCue® Plus
- Built-in 2.5 amp battery charger
- Remote two-wire start/stop capability for optional connection of Model RDT transfer switches
- Diagnostic messages
  - Displays diagnostic messages for the engine, generator, Model RXT transfer switch, programmable interface module (PIM), and load management device
  - Over 70 diagnostic messages can be displayed
- Maintenance reminders
- System settings
  - System voltage, frequency, and phase
  - Voltage adjustment
  - Measurement system, English or metric
- ATS status (Model RXT ATS required)
  - Source availability
  - ATS position (normal/utility or emergency/generator)
  - Source voltage and frequency
- ATS control (Model RXT ATS required)
  - Source voltage and frequency settings
  - Engine start time delay
  - Transfer time delays
  - Voltage calibration
  - Fixed pickup and dropout settings
- Programmable Interface Module (PIM) status displays
  - Input status (active/inactive)
  - Output status (active/inactive)
- Load control menus
  - Load status
  - Test function

## 1.7 OnCue Plus Generator Management System

The OnCue® Plus Generator Management System comes included with your generator and allows monitoring and control of your generator set from a personal computer, smart phone, or tablet. OnCue® Plus can be configured to send email or text message notifications in the event of a generator set fault. See the OnCue® Plus Software Operation Manual, for software instructions.

## 1.8 Accessories

The following optional accessories are offered for the RESV and RESVL generator sets.

### 1.8.1 Carburetor Heater

An optional carburetor heater is recommended for improved cold starting in locations where the ambient temperature drops below 0°C (32°F). The carburetor heater prevents condensation and carburetor icing. The heater requires a continuous source of 120 VAC power.

### 1.8.2 Programmable Interface Module (PIM)

The optional Programmable Interface Module (PIM) provides two programmable inputs and six programmable dry contact outputs for connection to customer-supplied equipment. The outputs are controlled by the RDC2 controller, and can also be controlled remotely using the OnCue® Plus program.

The PIM is mounted in a NEMA 3R aluminum enclosure, which can be mounted indoors or outdoors. See the installation instructions provided with the PIM.

### 1.8.3 Load Management

On models 8RESV, 10RESV, and 12RESV only, two optional load management devices are available for use when combined with a model RXT and RDT transfer switch:

- The optional Load Shed Kit mounts inside a model RDT or RXT transfer switch.
- The combined interface/load management board is available for the Model RXT transfer switch.

**Note:** Load shed kits are not available with the transfer switch supplied with models 8RESVL, 10RESVL, 12RESVL.

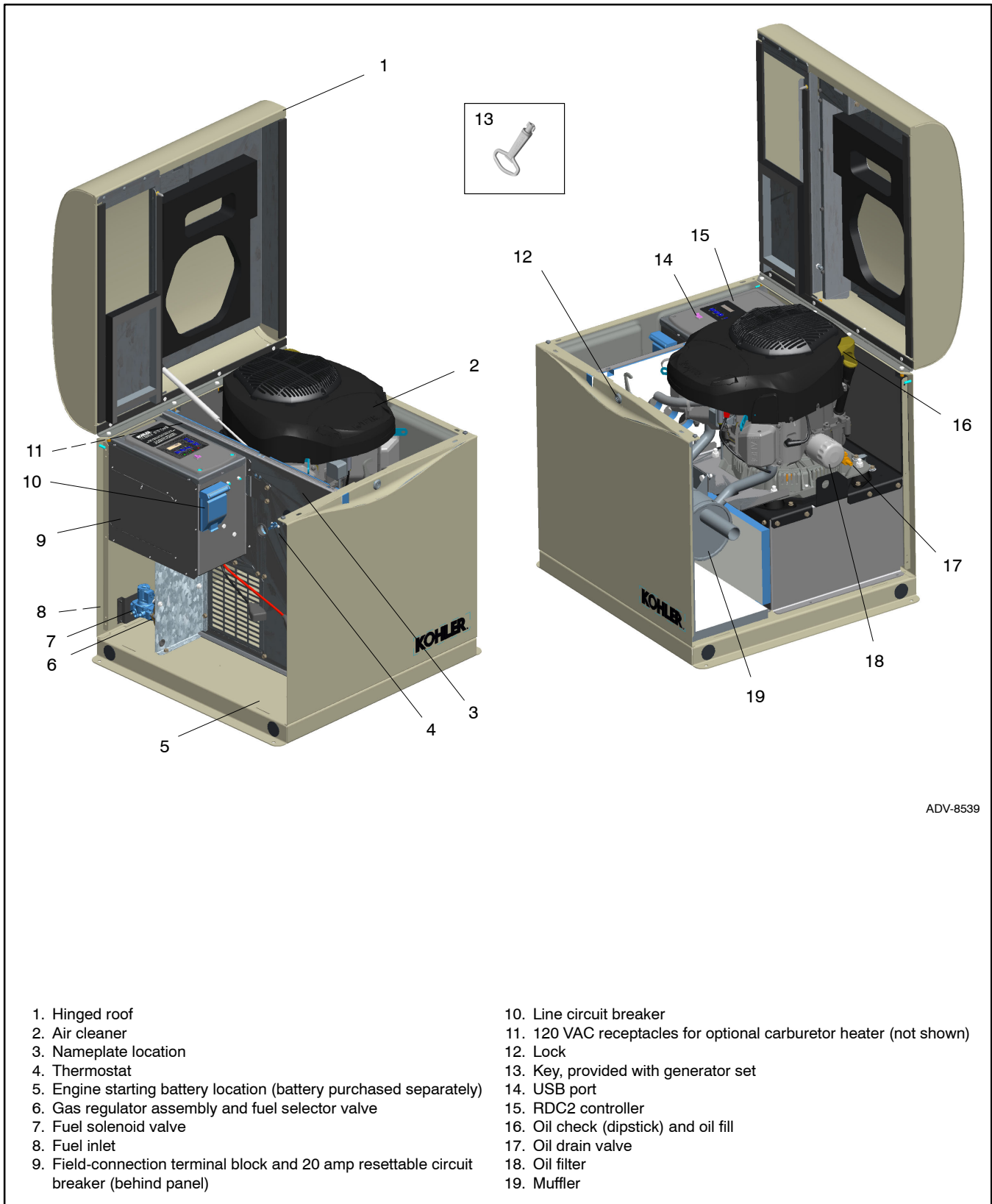
The load management devices provide an automatic load management system to comply with Section 702.5 of NEC 2008. The installer is responsible for ensuring that the power system installation complies with all applicable state and local codes.

**Note:** The load management devices are only compatible with single-phase generator sets.

The load management device automatically manages up to six residential loads. Two relays are provided to control two independent air conditioner loads. Up to four power relay modules (or customer-provided power relays) can be connected for management of non-essential secondary loads.

The load management device is controlled by the RDC2 controller. The load on the generator set is monitored, and loads are added or shed in the order of their priority. See the installation instructions provided with the load shed kit or the Model RXT Operation and Installation Manual for more information.

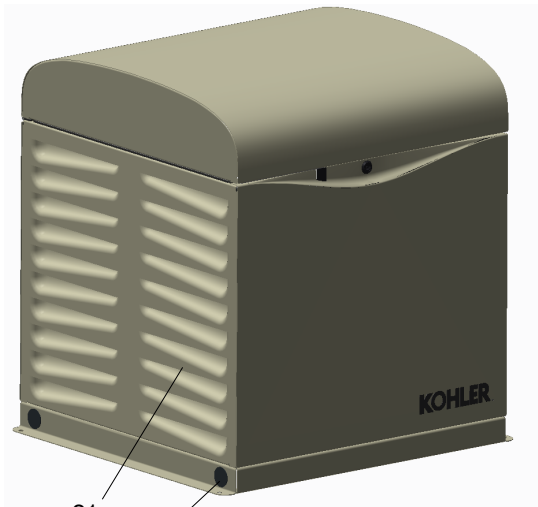
## 1.9 Service Views



ADV-8539

**Figure 1-2** Service View





20. Lifting holes  
21. Air intake




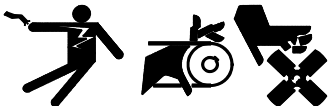
22. Exhaust outlet

**Figure 1-3** Service View



# Notes



## Section 2 Generator Set Operation

### 2.1 Prestart Checklist

 <b>WARNING</b>

<p><b>Accidental starting.</b> <b>Can cause severe injury or death.</b></p> <p>Disconnect the battery cables before working on the generator set. Remove the negative (-) lead first when disconnecting the battery. Reconnect the negative (-) lead last when reconnecting the battery.</p>

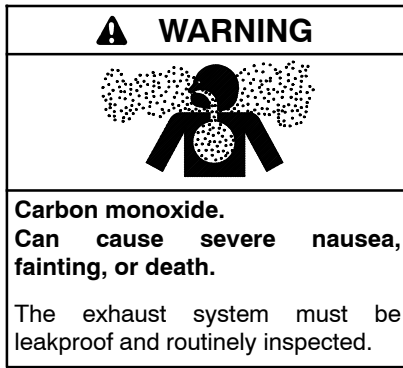
**Disabling the generator set. Accidental starting can cause severe injury or death.** Before working on the generator set or equipment connected to the set, disable the generator set as follows: (1) Press the generator set off/reset button to shut down the generator set. (2) Disconnect the power to the battery charger, if equipped. (3) Remove the battery cables, negative (-) lead first. Reconnect the negative (-) lead last when reconnecting the battery. Follow these precautions to prevent the starting of the generator set by the remote start/stop switch.

 <b>WARNING</b>

<p><b>Sulfuric acid in batteries.</b> <b>Can cause severe injury or death.</b></p> <p>Wear protective goggles and clothing. Battery acid may cause blindness and burn skin.</p>

 <b>WARNING</b>

<p><b>Explosion.</b> <b>Can cause severe injury or death.</b> <b>Relays in the battery charger cause arcs or sparks.</b></p> <p>Locate the battery in a well-ventilated area. Isolate the battery charger from explosive fumes.</p>

**Battery gases. Explosion can cause severe injury or death.** Battery gases can cause an explosion. Do not smoke or permit flames or sparks to occur near a battery at any time, particularly when it is charging. Do not dispose of a battery in a fire. To prevent burns and sparks that could cause an explosion, avoid touching the battery terminals with tools or other metal objects. Remove all jewelry before servicing the equipment. Discharge static electricity from your body before touching batteries by first touching a grounded metal surface away from the battery. To avoid sparks, do not disturb the battery charger connections while the battery is charging. Always turn the battery charger off before disconnecting the battery connections. Ventilate the compartments containing batteries to prevent accumulation of explosive gases.

**Battery electrolyte is a diluted sulfuric acid. Battery acid can cause severe injury or death.** Battery acid can cause blindness and burn skin. Always wear splashproof safety goggles, rubber gloves, and boots when servicing the battery. Do not open a sealed battery or mutilate the battery case. If battery acid splashes in the eyes or on the skin, immediately flush the affected area for 15 minutes with large quantities of clean water. Seek immediate medical aid in the case of eye contact. Never add acid to a battery after placing the battery in service, as this may result in hazardous spattering of battery acid.



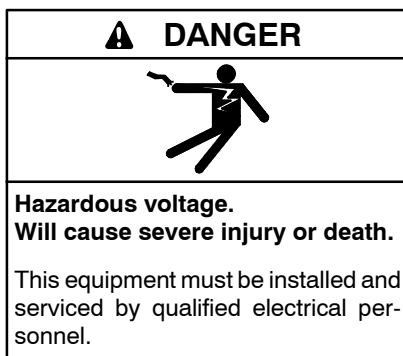
**Carbon monoxide symptoms. Carbon monoxide can cause severe nausea, fainting, or death.** Carbon monoxide is a poisonous gas present in exhaust gases. Carbon monoxide is an odorless, colorless, tasteless, nonirritating gas that can cause death if inhaled for even a short time. Carbon monoxide poisoning symptoms include but are not limited to the following:

- Light-headedness, dizziness
- Physical fatigue, weakness in joints and muscles
- Sleepiness, mental fatigue, inability to concentrate or speak clearly, blurred vision
- Stomachache, vomiting, nausea

If experiencing any of these symptoms and carbon monoxide poisoning is possible, seek fresh air immediately and remain active. Do not sit, lie down, or fall asleep. Alert others to the possibility of carbon monoxide poisoning. Seek medical attention if the condition of affected persons does not improve within minutes of breathing fresh air.

**Generator set operation. Carbon monoxide can cause severe nausea, fainting, or death.** Carbon monoxide is an odorless, colorless, tasteless, nonirritating gas that can cause death if inhaled for even a short time. Avoid breathing exhaust fumes when working on or near the generator set. Never operate the generator set inside a building. Never operate the generator set where exhaust gas could seep inside or be drawn into a potentially occupied building through windows, air intake vents, or other openings.

**Carbon monoxide detectors. Carbon monoxide can cause severe nausea, fainting, or death.** Install carbon monoxide detectors on each level of any building adjacent to the generator set. Locate the detectors to adequately warn the building's occupants of the presence of carbon monoxide. Keep the detectors operational at all times. Periodically test and replace the carbon monoxide detectors according to the manufacturer's instructions.



**Grounding electrical equipment. Hazardous voltage will cause severe injury or death.** Electrocuting is possible whenever electricity is present. Ensure you comply with all applicable codes and standards. Electrically ground the generator set, transfer switch, and related equipment and electrical circuits. Turn off the main circuit breakers of all power sources before servicing the equipment. Never contact electrical leads or appliances when standing in water or on wet ground because these conditions increase the risk of electrocution.

**Connecting the battery and the battery charger. Hazardous voltage will cause severe injury or death.** Reconnect the battery correctly, positive to positive and negative to negative, to avoid electrical shock and damage to the battery charger and battery(ies). Have a qualified electrician install the battery(ies).

**Short circuits. Hazardous voltage/current will cause severe injury or death.** Short circuits can cause bodily injury and/or equipment damage. Do not contact electrical connections with tools or jewelry while making adjustments or repairs. Remove all jewelry before servicing the equipment.

To ensure continued satisfactory operation, perform the following checks or inspections before or at each startup, as designated, and at the intervals specified in the service schedule. In addition, some checks require verification after the unit starts.

**Air Cleaner.** Check for a clean and installed air cleaner element to prevent unfiltered air from entering the engine.

**Air Inlets.** Check for clean and unobstructed air inlets.

**Battery.** Check for tight battery connections. Consult the battery manufacturer's instructions regarding battery care and maintenance.

**Exhaust System.** Check for exhaust leaks and blockages. Check the muffler condition.

- Inspect the exhaust system components for cracks, leaks, and corrosion. Check for tight exhaust system connections.
- Check for corroded or broken metal parts and replace them as needed.
- Check that the exhaust outlet is unobstructed.

**Oil Level.** Check the oil level before starting the generator set and at the intervals given in Section 4, Scheduled Maintenance. Maintain the oil level at or near, not over, the full mark on the dipstick.

**Operating Area.** Check for obstructions that could block the flow of cooling air. Keep the air intake area clean. Do not leave rags, tools, or debris on or near the generator set.

## 2.2 Exercising the Generator Set

Operate the generator set without load once each week for 20 minutes. See Section 2.4 for information about loaded and unloaded exercise modes. For instructions to set the exerciser, see Section 3.6.

## 2.3 Generator Set Operation

### 2.3.1 Local Starting and Stopping

**Start:** Press the RUN button to immediately start the generator set.

**Stop:** Press the OFF button. The engine stops.

Run the generator set with no load for at least 2 minutes to ensure adequate engine cooldown.

### 2.3.2 Automatic Starting and Stopping

An automatic transfer switch monitors the utility power and signals the generator set to start when utility power is lost. The ATS then transfers the load to the generator set.

When utility power is restored, the transfer switch transfers the load back to utility, runs the generator set with no load to cool down the engine, and then stops the generator set.

### 2.3.3 Remote Starting and Stopping

A remote switch connected to terminals 3 and 4 can be used to start and stop the generator set. Close the switch to start and run the generator set. Open the switch to stop the generator set.

Run the generator set with no load for at least 2 minutes to ensure adequate engine cooldown.

### 2.3.4 Engine Start Crank Cycle

The controller attempts to start the generator set three times (three crank cycles, 15 seconds crank and 15 seconds off). If the generator set does not start in three attempts, the system shuts down on an overcrank fault. See Section 2.5.

Cranking 1, 2, and 3 are displayed during the crank cycle. Pressing the OFF button during the crank cycle stops the cranking. No other buttons are acknowledged during the crank cycle.

### 2.3.5 Engine Cooldown

The engine cooldown time delay allows the engine to run after the loads have been removed.

The engine cooldown time delay is set to 5 minutes. The engine stops before the cooldown time delay expires if the temperature drops below the cooled-down temperature level, or if the temperature rises above the high limit during the cooldown cycle.

If a transfer switch other than the Model RXT is used, an additional engine cooldown time delay may be programmed on the transfer switch. To allow the smart engine cooldown on the RDC2 controller to operate most efficiently, set the cooldown time on the transfer switch controller to zero or the minimum time allowed. Refer to the instructions provided with the transfer switch for more information.

### 2.3.6 Automatic Operation with Model RXT Transfer Switch

The Model RXT transfer switch connects to the RDC2 controller through the ATS interface board on the transfer switch. Also see the Model RXT Transfer Switch Operation/Installation Manual for more information about transfer switch operation.

The controller must be in AUTO mode for automatic transfer switch operation.

#### Automatic Start

The RDC2 controller receives utility source voltage sensing data from the Model RXT transfer switch.

1. If the utility source voltage falls below an acceptable level, the controller starts the engine start time delay.
2. If the utility source is not restored before the time delay expires, the generator set starts.
3. After the Normal-to-Emergency time delay, the ATS is signaled to transfer the load to the emergency source.

#### Automatic Stop with Engine Cooldown

1. When the utility source is restored, the Emergency-to-Normal time delay starts.
2. When the Emergency-to-Normal time delay expires, the load is transferred to the utility.

3. The generator set runs through the engine cooldown cycle and then stops.

### 2.3.7 Automatic Operation with Other Transfer Switches

If a transfer switch other than the Model RXT (such as a Kohler Model RDT) is used, the engine start contacts from the ATS must be connected to engine start leads 3 and 4 on the generator set.

The controller must be in AUTO mode to respond to remote start/stop signals from an ATS or remote switch. Press the AUTO button to put the controller into automatic mode.

#### Automatic Start

The engine start contacts on the ATS close to signal the generator set to start, and remain closed while the generator set is running.

#### Automatic Stop

The engine start contacts on the ATS open to signal the generator set to stop.

## 2.4 Exercise

The RDC2 controller can be set to automatically run the generator set at the same time and day each week. Exercising the generator set weekly or every two weeks is required to keep the engine and alternator in good operating condition.

Three exercise modes are available: unloaded cycle, unloaded full speed, and loaded full speed. See Sections 2.4.2 through 2.4.4 for information about the exercise modes. A loaded exercise can be set at the RDC2 controller only if a Model RXT transfer switch is connected.

**Note:** With transfer switches other than the Model RXT, it is possible to have two exercise settings (one unloaded exercise set at the generator set controller, and another exercise set at the ATS controller). If the exercise times overlap, the ATS exercise setting takes priority.

If a transfer switch other than the Model RXT is used, refer to the instructions provided with the transfer switch to set a loaded exercise at the ATS, if desired.

### 2.4.1 Setting the Exerciser

When power is applied to the RDC2 controller (that is, when the battery is connected), you will be prompted to set the date and time, and then to set the exerciser.

The first setting will flash. Press the Up and Down arrow buttons to change the setting. Press Select to save the setting and move on to the next. See Section 3.5 for more detailed instructions to change settings on the RDC2. See Section 3.6 for more detailed instructions to set the exerciser or change the exercise settings.

### 2.4.2 Unloaded Cycle Exercise with Complete System Diagnostics

An unloaded exercise runs the generator set without signalling the transfer switch to transfer the electrical load from the utility source to the generator set. The Unloaded Cycle exercise with diagnostics is the recommended exercise mode and is the default exercise setting.

The Unloaded Cycle exercise runs the engine for 20 minutes in the cycle shown in Figure 2-1 and described below.

- Runs at reduced speed for 10 minutes to warm up and exercise the engine.
- Ramps up and runs at full speed for 3 minutes. Engine diagnostics are performed during this full-speed portion of the cycle, which provides the best test of engine and alternator power backup capability. Diagnostic tests at full speed can identify potential problems with the power output and alert the operator before an emergency event.
- Ramps down and runs at reduced speed for 5 minutes to cool down the engine before shutting down automatically.

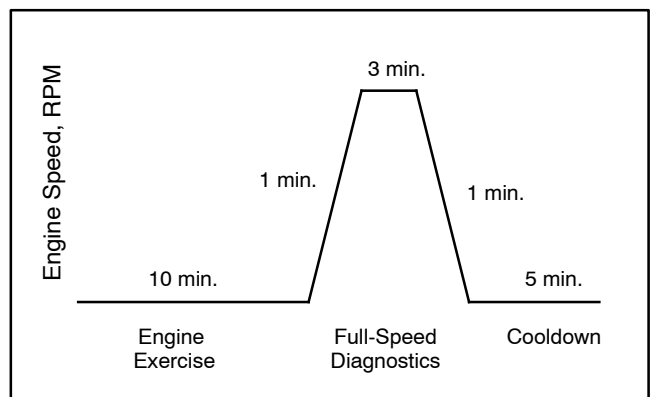


Figure 2-1 Unloaded Exercise Cycle

## System Diagnostics

During the unloaded exercise, the controller monitors the following data. The controller display indicates that the generator set is running, unless a fault is detected as described below.

- **ATS connection.** The controller verifies that the Model RXT ATS interface board is connected.
- **Battery voltage.** Battery voltage is checked before exercise to verify engine starting capability. Battery voltage provides a measurement of battery health. If the controller detects low battery voltage, the condition is indicated on the display.
- **Communication integrity tests.** J1939, RBUS, Ethernet, and USB are monitored for messages indicating that the controller and wiring are reliable.
- **Engine speed.** Engine speed is measured at reduced speed and full speed. An overspeed or underspeed condition will result in a fault condition and shutdown.
- **Generator output frequency and voltage.** Operating the generator at full speed allows the RDC2 controller to check the output power for correct voltage, frequency, and stability. When the engine is running at full speed, the controller verifies that the voltage and frequency are within acceptable limits. A fault message is displayed if the voltage or frequency is out of range.
- **Oil pressure.** Oil pressure is verified to ensure proper lubrication of critical engine components. Pressure is monitored at both reduced and full speeds. If the oil pressure is low, the Low Oil Pressure message is displayed and the generator set shuts down.

## 2.4.3 Unloaded Full-Speed Exercise

The unloaded full-speed exercise runs the generator set at full speed for 20 minutes without transferring the load.

To set an unloaded full-speed exercise, follow the procedure in Figure 3-8 and select Exercise Mode: Unloaded Full.

## 2.4.4 Loaded Full-Speed Exercise (with RXT only)

A loaded exercise starts the generator set, ramps up to full speed, and then transfers the electrical load from the utility source to the generator set. After 20 minutes, the load is transferred back to the utility source. The engine runs without load for 5 minutes or until cool, and then shuts down automatically.

**Note:** With a loaded exercise, power to the building is lost for up to 10 seconds during load transfer.

For a loaded exercise controlled by the RDC2 controller, a Model RXT transfer switch must be connected to the generator set. To set a loaded exercise, follow the procedure in Figure 3-8 and select Exercise Type: Loaded.

For a loaded exercise with a transfer switch other than a Kohler® Model RXT, program the exercise at the transfer switch controller. Refer to the transfer switch operation manual for instructions.

## 2.4.5 Power Failure During Exercise Cycle

If the utility power is lost during an unloaded exercise, the ATS transfers to the emergency source, the exercise is ended and the control remains in the AUTO mode.

If the utility power is lost during a loaded exercise, the exercise is ended. The ATS remains in the emergency position and the control goes into the AUTO mode.

The generator set continues to run and supply power to the load for the duration of the utility power outage. When Utility power is restored, the ATS will re-transfer to the utility source through normal timing sequences.

## 2.5 Faults

The RDC2 controller displays fault messages for generator set warnings and shutdowns. Selected fault messages are shown in Figure 2-3.

### 2.5.1 Warnings

The controller displays a fault message but the generator set does not shut down on a warning. The controller resets automatically after a warning condition is corrected.

### 2.5.2 Shutdowns

Under a fault shutdown condition, the generator set shuts down automatically and the controller displays a fault message. The OFF LED flashes. In some cases, the engine cooldown cycle runs before the engine shuts down. See Figure 2-3.

Shutdown switches (such as the low oil pressure switch or high engine temperature switch) on the generator set will automatically reset when the problem is corrected. However, the fault condition at the controller does not clear until the controller is reset.

The generator set cannot be restarted until the fault condition is corrected and the controller is reset. See Section 2.5.4 for instructions to reset the controller after a fault shutdown.

### 2.5.3 ATS Communication Errors

When a Model RXT transfer switch is used, an ATS fault indicates that the connection to the interface board on the transfer switch has been lost. Check the connection to the ATS interface board.

### 2.5.4 Resetting the Controller after a Fault Shutdown

Always identify and correct the cause of a fault shutdown before resetting the controller. Check the fault message displayed on the controller and refer to Figure 2-3 to identify and correct the fault condition before proceeding. Contact an authorized distributor/dealer for service, if necessary.

#### RDC2 Controller

Press the OFF button to reset the controller, or follow the procedure below. See Figure 2-2.

1. While the fault message is displayed, press the Select button to go to the Overview menu.
2. Press Select again. The active fault message is displayed.
3. Press Select. Confirm Clear Fault: NO is displayed.
4. Press the Down arrow button. Confirm Clear Fault: YES is displayed.
5. Press the Select button to enter YES and clear the fault.
6. Press the Select button to return to the overview menu. The controller changes to OFF mode.
7. Press AUTO to put the generator set into automatic mode.

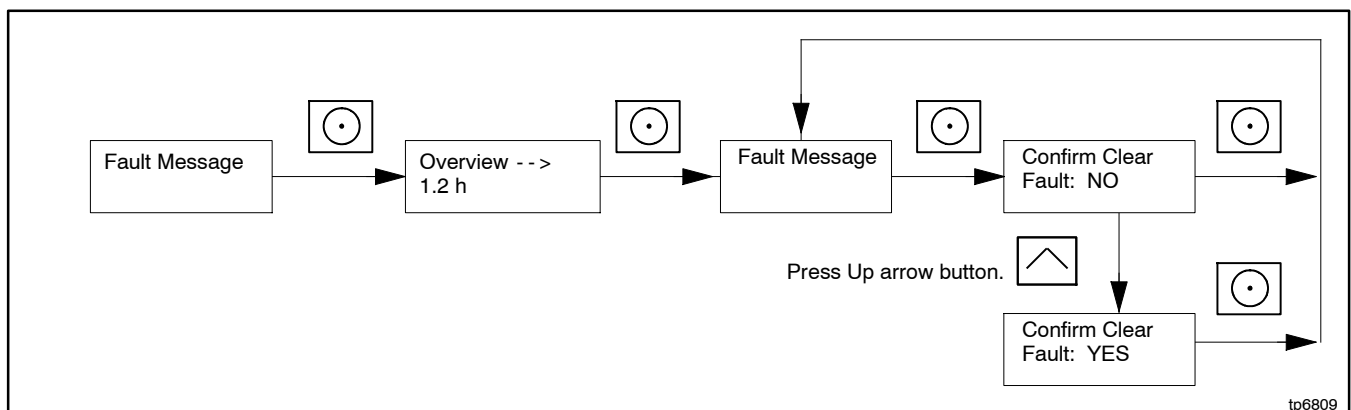


Figure 2-2 Clearing a Fault on the RDC2 Controller



<b>Fault Message</b>	<b>Warning (W) or Shutdown (SD)</b>	<b>Condition</b>	<b>Check</b>
AC Sens Loss	W (1 sec.) SD (3 sec.) *	AC sensing lost. In Auto mode, generator output AC sensing is lost. Detection begins 10 seconds after crank disconnect.  Warning: after 1 second if no output detected after crank disconnect.  Shutdown: after 3 seconds if voltage was present and then lost.	Contact an authorized distributor/dealer for service.
Accy PwrOver Warning	W	Accessory Power Overload. An over current fault (short circuit) on the accessory controller power output.	Contact an authorized distributor/dealer for service.
Alt Protect	SD	High generator current has been detected. The generator set shuts down to protect the alternator from damage caused by overheating the windings (10RESV and 12RESV only).	Reduce the load.
ATS ComError	W	ATS communication error. Warning is displayed if ATS interface connection is lost. See Section 2.5.3.	Check communication wiring between transfer switch interface board and generator set.
ATS PhaseRot	W	ATS phase rotation mismatch. Transfer switch phase rotation does not match, ATS will not transfer.	Correct the ATS connection. Refer to the ATS Installation manual, wiring diagrams, and labels on the transfer switch.
Aux Input	SD *	Auxiliary input. An optional customer-connected input is closed. (Digital input from optional PIM.)	Check customer-supplied equipment.
Batt Chg Flt	W	Battery charger fault. Input to PIM from an external battery charger (not the built-in battery charger).	Check external battery charger.
Battery High	W	Engine starting battery voltage rises above 16 VDC for more than 10 seconds. Inhibited during the engine crank cycle.  Clears when the battery voltage returns to an acceptable level.	Check the battery rating and condition.  Check the battery charger operation.
Battery Low	W	Engine starting battery voltage falls below 12.5 VDC for more than 90 seconds when the engine is not running. Not operative during the engine crank cycle.  Clears when the battery voltage returns to an acceptable level.	Check the battery rating and condition.  Check the battery charger operation.  Charge or replace the battery.
Battery CrLo Warning	W	Engine starting battery voltage falls below 11 Volts for more than 10 seconds. Inhibited during the engine crank cycle.  Clears when the battery voltage returns to an acceptable level.	Check the battery rating and condition.  Check the battery charger operation.  Charge or replace the battery.
Eng Speed High	SD *	Engine speed exceeds 115% of the normal running speed for more than 0.3 seconds.	Contact an authorized distributor/dealer for service.
Eng Speed Low	SD *	Engine speed drops below 85% of the normal running speed for more than 3 seconds.	Reduce the load.  Contact an authorized distributor/dealer for service.
Exer Not Sch	W	Exercise not scheduled. No exercise is scheduled on the controller.	See Section 3.6 for instructions to set the exerciser.

\* Engine cooldown runs before shutting down.

Fault	Warning (W) or Shutdown (SD)	Condition	Check
Frequency High	SD *	Governed frequency exceeds 110% of the system's frequency setpoint for more than 10 seconds. Function becomes active 10 seconds after engine start (10 second inhibit).	Contact an authorized distributor/dealer for service.
Frequency Low	SD *	Governed frequency falls below 90% of the system frequency setting for more than 10 seconds, or 1 Hz below the system frequency setting for more than 60 seconds. Function becomes active 10 seconds after engine start (10 second inhibit).	Reduce the load and restart the generator set. Contact an authorized distributor/dealer for service.
Lo Crank Vlt	W	Low cranking voltage. Battery voltage falls below 8 VDC for more than 6 seconds while the starter is engaged.	Charge or replace the battery.
MainPwrOverL	SD	Main power overload. An over current fault on the 70 controller power output (short circuit).	Contact an authorized distributor/dealer for service. Check for shorted run relay. Check wiring for short circuits.
Not in Auto	W	The generator set is not in Automatic (standby) mode. Remote start and stop commands from a transfer switch or remote switch will be ignored.	Press AUTO to place the generator set in Automatic mode, when appropriate.
Oil Pres Low	SD *	The LOP switch indicates low oil pressure for more than 5 seconds. Function becomes active 30 seconds after crank disconnect (30 second inhibit). <b>Note:</b> The low oil pressure shutdown does not protect against low oil level. Check the engine oil level regularly as recommended in Section 4.	Check for leaks in the lubrication system. Check the oil level and add oil if the level is low. Check the oil pressure switch and wiring
Over Crank	SD	Three unsuccessful starting attempts.	Check the fuel supply, spark plug, and battery. Reset the thermostat. Check for loose connections. Contact an authorized distributor/dealer for service.
Spd Sens Flt	SD	Engine speed sensor has failed or engine stalled.	Contact an authorized distributor/dealer for service.
Total Power High	SD	Measured load is greater than 102% of the generator set power rating for more than 1 minute (10RESV and 12RESV only).	Reduce the load.
Volts L1-L2 High	SD *	Generator voltage high. Output voltage exceeds 120% of the system nominal voltage for more than 2 seconds.	Contact an authorized distributor/dealer for service.
Volts L1-L2 Low	SD *	Generator voltage low. Output voltage falls below 80% of the nominal system voltage for more than 10 seconds.	Reduce the load and restart the generator set. Contact an authorized distributor/dealer for service.

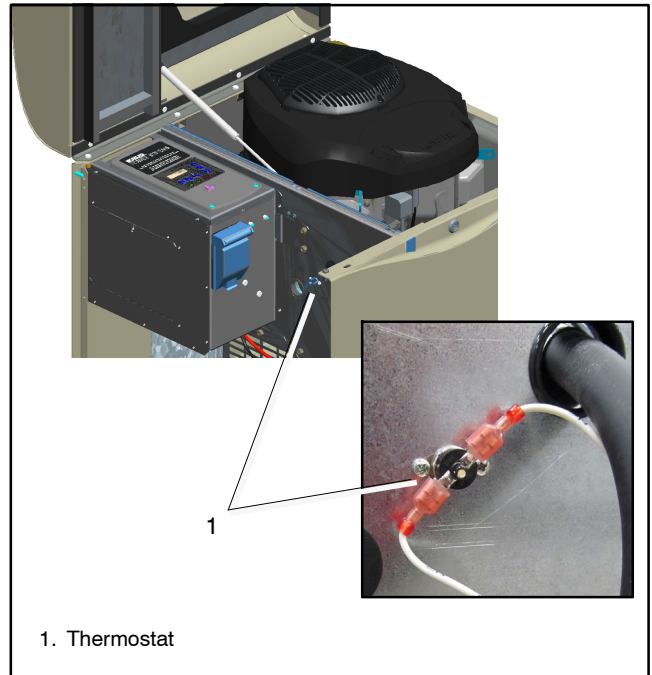
\* Engine cooldown runs before shutting down.

**Figure 2-3** Controller Fault Messages

## 2.6 Generator Enclosure Thermostat

8RESV(L), 10RESV(L), and 12RESV(L) generators include a resettable thermostat in the air intake compartment. The thermostat detects excess heat inside the enclosure. If the thermostat trips, the generator will shut down and the controller will display a fault (underspeed, underfrequency, or undervoltage). If the thermostat trips for some reason other than high temperature (i.e. a nuisance trip), follow these steps to reset the thermostat.

1. Disconnect the utility power to the generator by opening (turning OFF) the corresponding circuit breaker at the building's distribution panel.
2. Open the enclosure roof.
3. Press the button on the thermostat to reset it. See Figure 2-4 for the thermostat location.
4. Reconnect utility power to the generator set by closing the circuit breaker in the distribution panel.
5. Reset the fault on the RDC2 controller. See Section 2.5.4.



**Figure 2-4** Thermostat Location

# Notes

## Section 3 RDC2 Controller Operation

### 3.1 RDC2 Generator Set/ Transfer Switch Controller

The generator sets are equipped with the RDC2 generator set/transfer switch controller.

The RDC2 controls the following power system components:

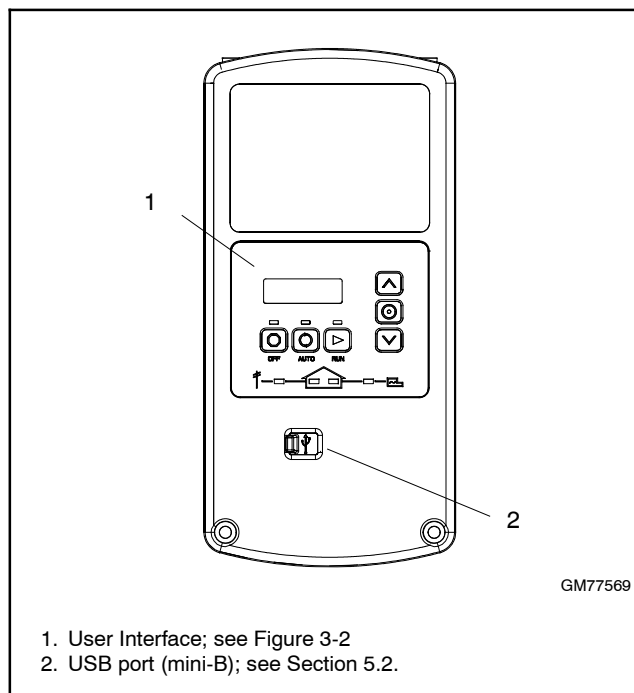
- Model 8RESV/L, 10RESV/L, or 12RESV/L generator set
- Model RXT Automatic Transfer Switch (ATS)
- Load shed kit
- Programmable Interface Module (PIM)

The RDC2 controller features include:

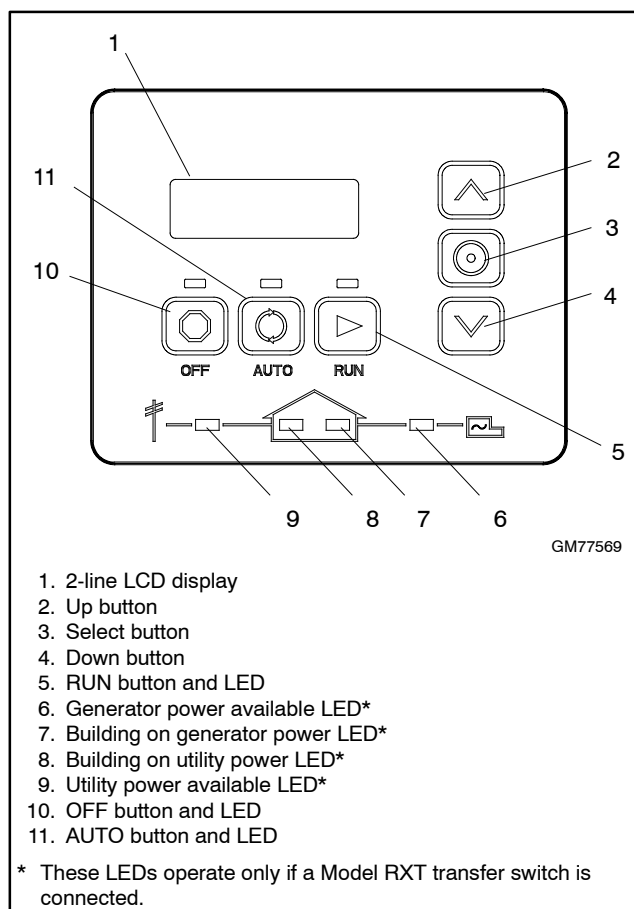
- Two-line x 16 character backlit digital display with adjustable contrast
- OFF, AUTO, and RUN generator set master control buttons
- Generator set status indicating LEDs (OFF, AUTO, RUN)
- Up, Down, and Select buttons for navigation through menus and adjustments
- Power system indicator LEDs to show utility and generator source status, and to show which source (utility or generator) is supplying power to the load

### 3.2 Controls and Indicators

Figure 3-1 illustrates the RDC2 controller. See Figure 3-2 for details of the controller's user interface.



**Figure 3-1** RDC2 Controls and Indicators



**Figure 3-2** RDC2 User Interface

### 3.2.1 Controller Keypad

The RUN, OFF, and AUTO buttons control the generator set as described in Figure 3-3.

Use the Select, Up arrow, and Down arrow buttons to navigate through the menus and change settings, if necessary. See Section 2.3 for operation instructions.

### 3.2.2 LED Indicators

LEDs above the RUN, OFF, and AUTO buttons indicate the mode of operation as shown in Figure 3-4.

Power System LEDs indicate the status of the utility power and the generator set, and indicate which source is supplying power to the building (based on the position of the RXT transfer switch). See Figure 3-2 and Figure 3-4.

**Note:** The power system LEDs operate only if a Model RXT transfer switch is connected. They will not operate if a different transfer switch is used.

Button	Button Function
RUN	Starts the generator set. The engine start time delay is ignored.
OFF	Stops the generator set. The cooldown time delay is ignored. During the engine crank cycle, pressing OFF will stop the crank cycle. Press OFF to clear faults and reset the controller.
AUTO	Places the generator set in Automatic (standby) mode.
Down arrow	Use to navigate through menus and change settings. This manual contains instructions to navigate the controller menus and adjust settings on the RDC2 controller.
Select	
Up arrow	

**Figure 3-3** RDC2 Controller Pushbutton Operation

LED	LED Operation
RUN	Lights when the generator set has been started locally by pressing the RUN button. Remote start and stop commands are ignored.
OFF	Lights for 2 seconds, then flashes every 2 seconds when the generator set and controller are off. Remote start/stop commands have no effect. The exercise cycle will not run.  In Auto mode, OFF LED flashes quickly to indicate a fault shutdown. Attention required. Identify and correct the fault condition before resetting the controller.
AUTO	Lights when the generator is in automatic (standby) mode. Generator set will respond to engine start and stop commands from the controller (for example, exercise start and stop commands) or an ATS. Time delays operate as described in Section 2.3.
Utility Power Available *	Lights when utility power is available.
Building on Utility Power *	Lights when the building load is connected to utility power through the RXT transfer switch.
Generator Power Available *	Lights when generator power is available.
Building on Generator Power *	Lights when the building load is connected to generator power through the RXT transfer switch.

\* These LEDs operate only if a Model RXT transfer switch is connected.

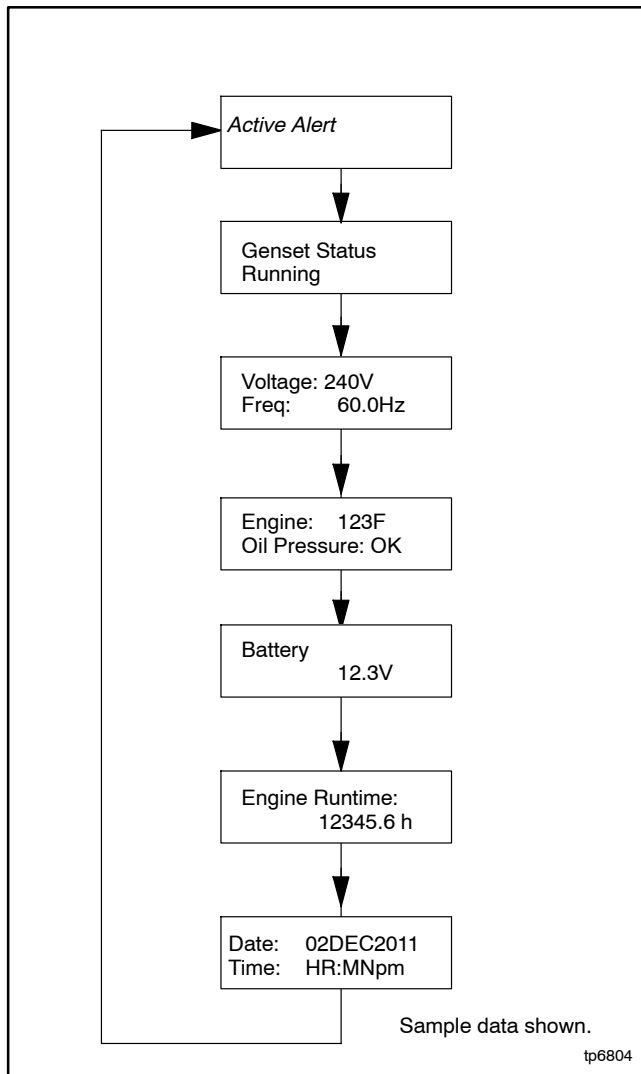
**Figure 3-4** RDC2 Controller LED Operation

### 3.2.3 LCD Display

The controller is equipped with a two-line x 16 character backlit digital display with adjustable contrast. When the generator is running, the controller automatically scrolls through the displays shown in Figure 3-5. When the system is in AUTO, the screens shown in Figure 3-6 are displayed.

When a fault or warning condition exists, the controller will show the corresponding message. See Section 2.5 for more information about faults.

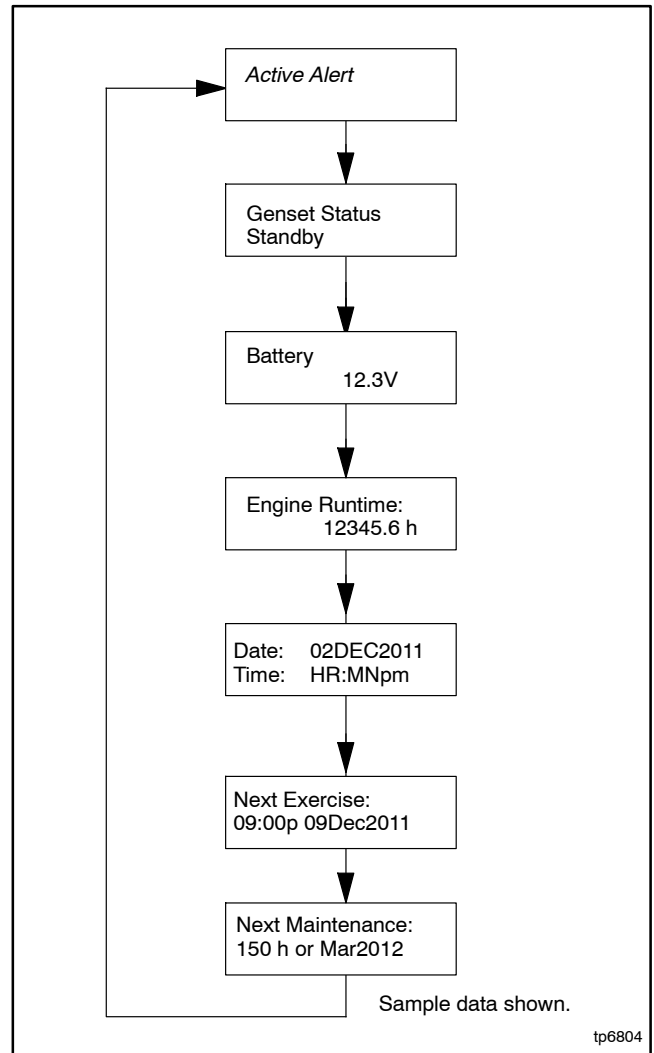
Controller menus display power system information, including status information for the engine, generator, and optional RBUS accessories, exercise settings, and event history. Some menus allow changes to the controller settings. See Sections 3.7 through 3.21 for menu diagrams.



**Figure 3-5** Autopaging Displays, Generator Running

The display contrast is adjustable. Navigate to the Genset System menu and step down to the Contrast screen. Press the Select button, and then use the up and down arrow buttons to adjust the contrast. See Section 3.5, Changing Settings, and Section 3.14, Genset System Menu.

The display backlight turns off after about a minute of no activity. The backlight turns on when a button is pressed or when the generator set starts.



**Figure 3-6** Autopaging Displays, Automatic Mode

### 3.3 Controller Power

The RDC2 controller is powered by the generator set engine starting battery and the built-in battery charger.

**Note:** To disconnect controller power, disconnect the utility power to the generator set and disconnect the battery.

If controller power is disconnected and reconnected, you will be prompted to set the time, date, and exerciser. The first setting will flash. Press the Up and Down arrow buttons to change the setting. Press Select to save the setting and move on to the next. Repeat until all settings are saved and the controller returns to the main menu. See Section 3.5 for more detailed instructions to change settings on the RDC2. See Section 3.6 for more detailed instructions to set the exerciser or change the exercise settings.

### 3.4 Battery Charging

The controller includes a built-in battery charger to maintain the engine starting battery. The RDC2 controller monitors the battery voltage and provides a constant  $14.0 \pm 2\%$  VDC voltage and maximum 2.5 amps to charge the battery.

The installer must connect 120 VAC/60Hz utility power provided from the building on a breaker-protected circuit for the built-in battery charger.

### 3.5 Changing Settings

Some settings can be changed from the controller keypad. The controller settings and generator set output are factory-set and should not require field adjustment under normal circumstances. Check and adjust the settings and/or output when:

- The controller has been replaced.
- The voltage requires adjustment for a particular application.
- Troubleshooting generator set problems.

Have controller setup and adjustment performed only by an authorized Kohler distributor/dealer or authorized representative.

The following procedure explains how to change settings. See Figure 3-7 for an example using the Date and Time settings.

**Note:** Use caution when navigating the controller menus. In some menus, pressing the Select button can enable editing of the controller settings. Changing the settings to incorrect values can adversely affect generator set operation or render the unit inoperable.

#### Procedure to Change Settings

1. Press the Select button to enter the main menu.
2. Press the down arrow button until the desired menu is displayed. The Genset System menu is used for this example. See Figure 3-9.
3. Press the Select button to enter the genset system displays. See Figure 3-7.
4. Press the down arrow button to step through the generator set system settings.
5. To change any of the genset system settings, press the Select button. The selected setting flashes.
6. Press the up or down arrow buttons to increase or decrease the setting.
7. When the desired setting is shown, press Select. The value stops flashing. If there are additional adjustable settings on the screen, the next setting flashes. For example, in the date menu, the day, month, and year can be adjusted.
8. Repeat steps 6 and 7 for each setting on the screen.
9. Press the down arrow to step to the next screen.
10. To exit, press the down arrow button until Return is displayed. Press the Select button to exit the menu.
11. Press the AUTO or OFF button to exit the main menu.

**Note:** If no buttons are pushed, the controller exits the menus and returns to the generator set status display after 5 minutes.



## Changing Settings on the RDC2 Controller

1. Press the Select button to enter the main menu.



2. Press the down arrow button until the desired menu is displayed. See Figure 3-9. Date and Time are used for this example.



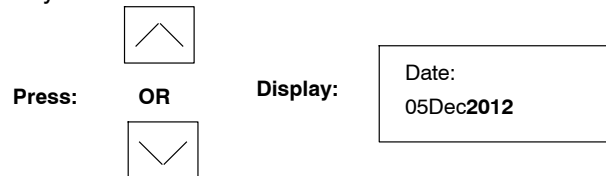
3. Press the Select button to enter the Date and Time menu.



4. To change the date and time settings, press the Select button again. The year will flash.



5. Press the up or down arrow buttons to change the year.



6. When the correct year is shown, press the Select button. The year is saved and the next setting (month) flashes.



7. Repeat steps 5 and 6, using the arrow and select buttons to set the month and the date.

8. When the correct date is shown, press the Select button. The saved date is shown.



9. Press the down arrow button to step to the next menu.



10. Repeat steps 5 and 6, using the arrow and select buttons to set and save the time.

**Note:** To change from am to pm, press the up arrow key to increase the hour until the correct hour and pm is displayed.

11. In the time format menu, press Select and then press the up or down arrow button to change the format, 12 hr. or 24 hr. Press Select to save the displayed format.

12. Press the down arrow button. Return is displayed.



13. Press Select to return to the Date and Time menu.



14. Press the Up or Down arrow buttons to step to a different menu.

15. Press Auto to signal the controller to exit the menus and return to the generator set status display.



**Note:** If no buttons are pressed, the controller returns to the status display after 5 minutes.

**Figure 3-7** Changing Settings

## 3.6 Setting the Exerciser

Set the exerciser to automatically run the generator set for 20 minutes every week or every two weeks.

### 3.6.1 Setting the Exerciser at Controller Power-up

When battery power is connected to the controller, you will be prompted to set the date and time, and then to set the exerciser.

The first setting will flash. Press the Up and Down arrow buttons to change the setting. Press Select to save the setting and move on to the next. See Section 3.5 for more detailed instructions to change settings on the RDC2.

If the battery is disconnected and reconnected during generator set maintenance or service, the time, date, and exercise settings will need to be re-entered.

### 3.6.2 Changing the Exercise Settings

This section explains how to change the exercise settings after the initial setup.

Follow the procedure below and see the flowchart in Figure 3-8 to set the exercise time and date, mode, and frequency.

#### Procedure to Set the Exerciser

1. Press the AUTO button on the controller.
2. Press the Select button to go to the main menu. See Figure 3-9.
3. Press the down arrow button to step to the Genset System menu.
4. Press the Select button to enter the Genset system menu. See Figure 3-8.
5. Use the down arrow button to step to the Next Exercise menu. If the exerciser is not set, No Exercise Scheduled will be displayed.
6. Press and HOLD the Select button to enable editing.

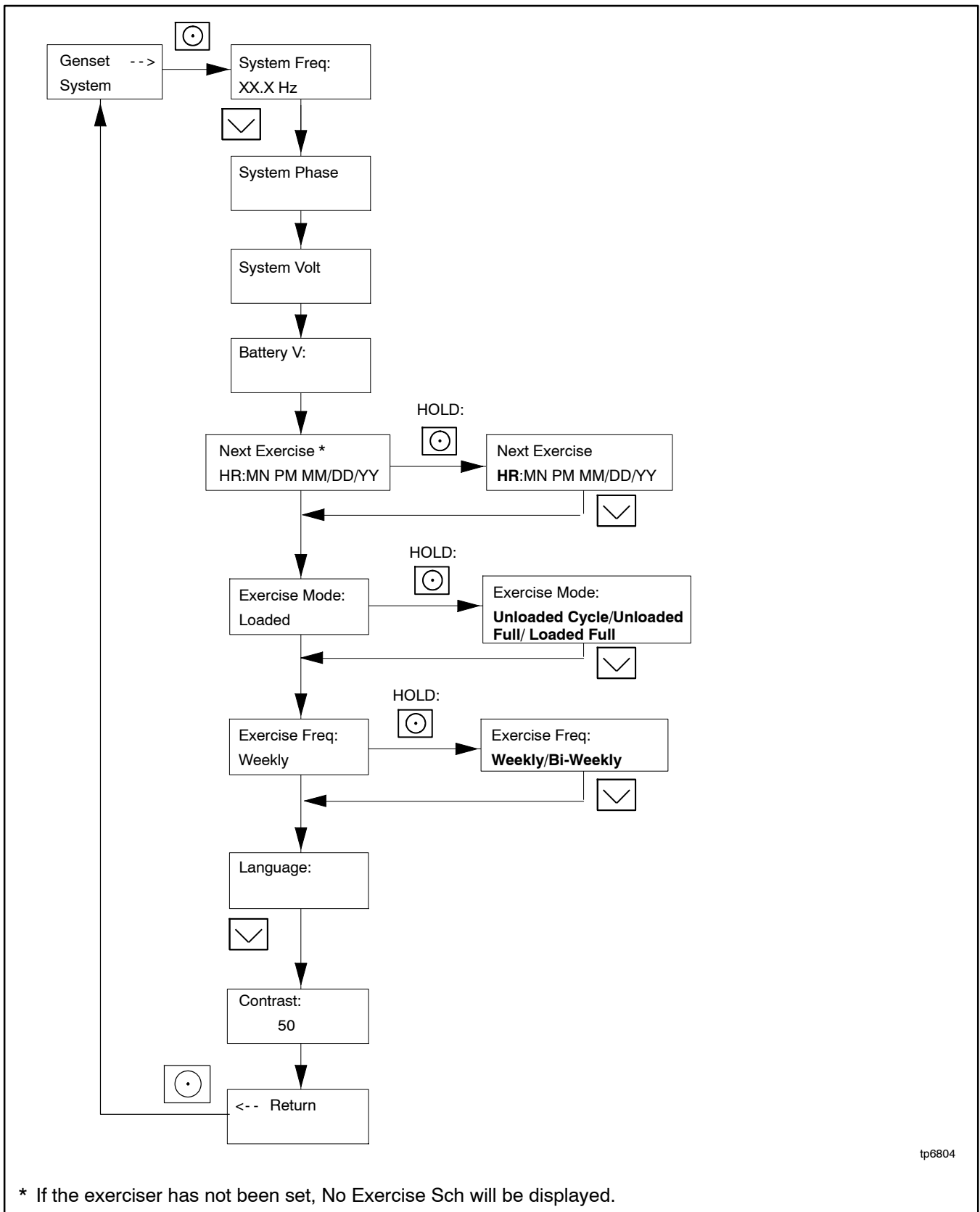
7. Press the Select button. The setting flashes to show that it can be changed. For example, HR flashes to show that the hour can be changed.
8. Press the Up or Down arrow buttons to change the setting.
9. Press the Select button to save the setting and move to the next. For example, save HR setting and move to MN.
10. Repeat steps 5 through 9 to change the next item on the line until the desired settings are displayed.
11. Press Select to save after all settings have been selected. Settings will stop flashing.
12. If the generator set is connected to a Kohler® Model RXT transfer switch, the exercise can be changed to a loaded exercise. Set the Exercise Mode to Unloaded Cycle, Unloaded Full, or Loaded Full (RXT ATS required) as shown in Figure 3-8. Unloaded Cycle is recommended. See Sections 2.4.2 through 2.4.4 for information about the exercise modes.
13. Set the exercise frequency (weekly or every two weeks). Weekly exercises are recommended.
14. Press the down arrow button to step to the Return menu. Press the Select button to return to the main menu.

After a scheduled exercise run, the next exercise time and date will be updated automatically based on the Exercise Frequency setting.

**Other transfer switches:** For a loaded exercise with a transfer switch other than a Kohler® Model RXT ATS, refer to the transfer switch operation manual for instructions.

#### Exerciser Reset

To reset the exerciser to run at a different day and/or time or to change the exercise mode, follow the procedure in Section 3.6.2 to change the exerciser settings.



**Figure 3-8** Procedure to Set the Exerciser on the RDC2 Controller

### 3.7 RDC2 Controller Menus

Controller menu display power system information, including status information for the engine, generator, and optional RBUS accessories, exercise settings, and event history. Some menus allow changes to the controller settings. Status information, including the engine runtime, cannot be changed by the operator.

Diagrams in the following sections show how to navigate through the menus.

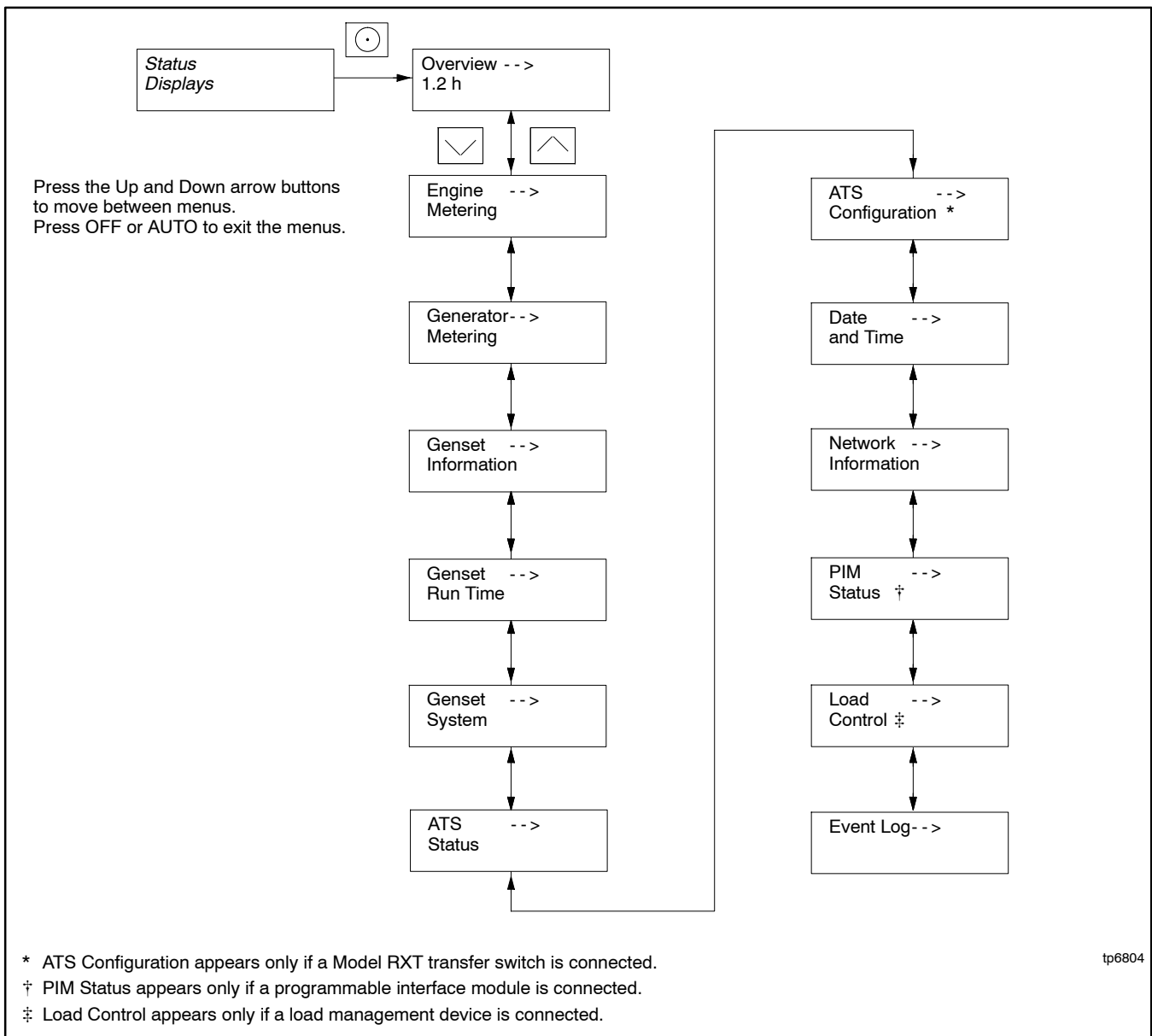
**Note:** Use caution when navigating the controller menus. In some menus, pressing the Select button can enable editing of the controller settings. Changing the settings to incorrect values can adversely affect generator set operation or render the unit inoperable.

If a setting on the controller display is flashing, edit mode has been enabled. Press the OFF or AUTO button to exit the edit mode.

### 3.8 Main Menu

Press the Select button once to bring up the main menu. Overview is displayed. See Figure 3-9. Press the down arrow button to step to the next menu, Engine Metering. Use the UP and DOWN arrow buttons to step up and down through the menus shown in Figure 3-9.

The controller will exit the main menu after 5 minutes if no buttons are pressed. To exit the main menu immediately, press the controller's OFF or AUTO button.



**Figure 3-9** RDC2 Main Menu

### 3.9 Overview Menu

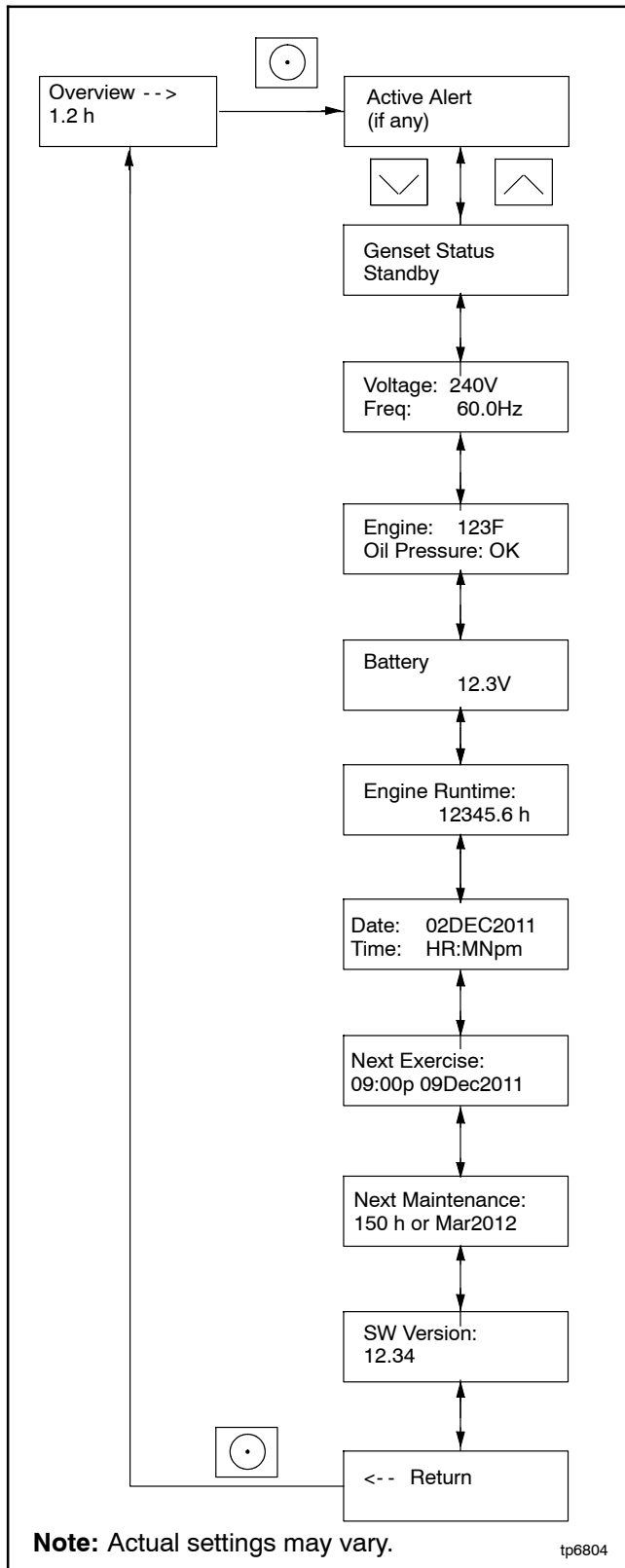


Figure 3-10 Overview Menu

### 3.10 Engine Metering Menu

The engine metering menu displays engine status information as shown in Figure 3-11. This menu displays status information only. No settings can be changed from this menu.

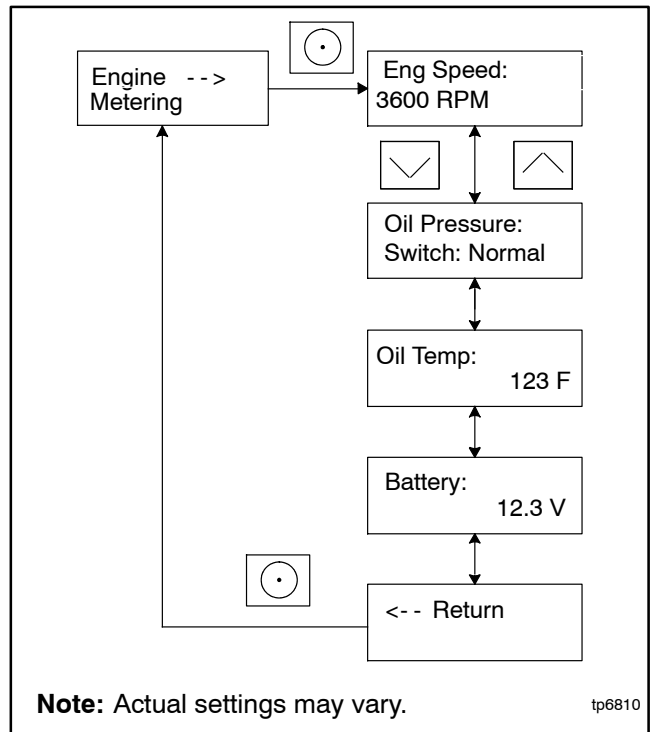



Figure 3-11 Engine Metering Menu

### 3.11 Generator Metering Menu

The generator metering menu displays the generator voltage and frequency. See Figure 3-12.

### Voltage Calibration

<b>⚠ DANGER</b>

<b>Hazardous voltage. Will cause severe injury or death.</b>
This equipment must be installed and serviced by qualified electrical personnel.

The voltage calibration mode can be entered from the Generator Metering menu. Contact a Kohler-authorized distributor/dealer for service.

The Reset Calibration menu allows you to set the voltage reading back to the original value after calibration, if necessary. See Figure 3-12.

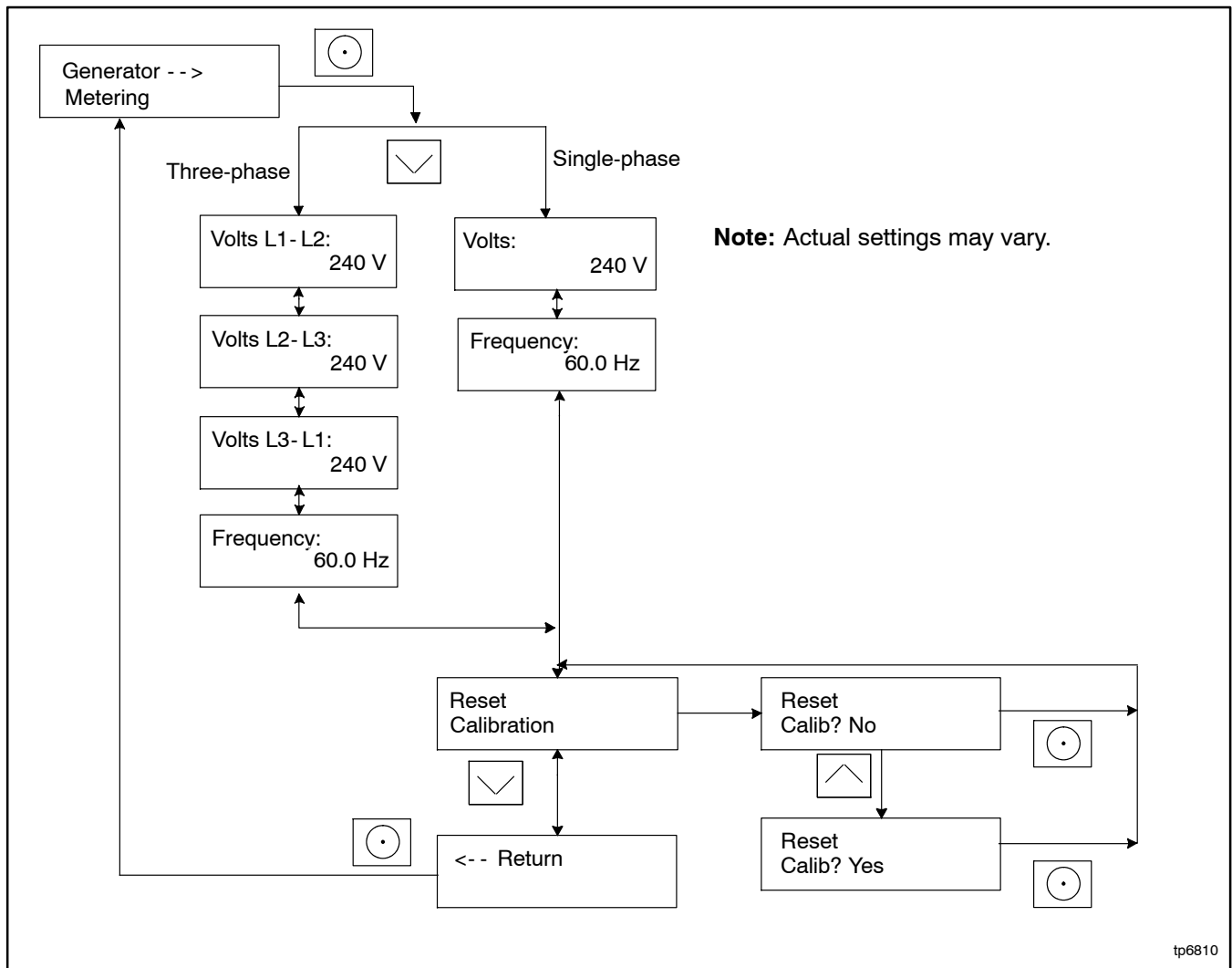


Figure 3-12 Generator Metering Menu

### 3.12 Generator Set Information Menu

The generator set model number and serial numbers are displayed. No changes are allowed from this menu.

Model and serial numbers are factory set and should not require changes in the field, except in the event that the controller is being replaced. A personal computer running Kohler SiteTech software is required to enter the generator set model number and serial numbers on a replacement controller. Contact an authorized Kohler distributor/dealer for service.

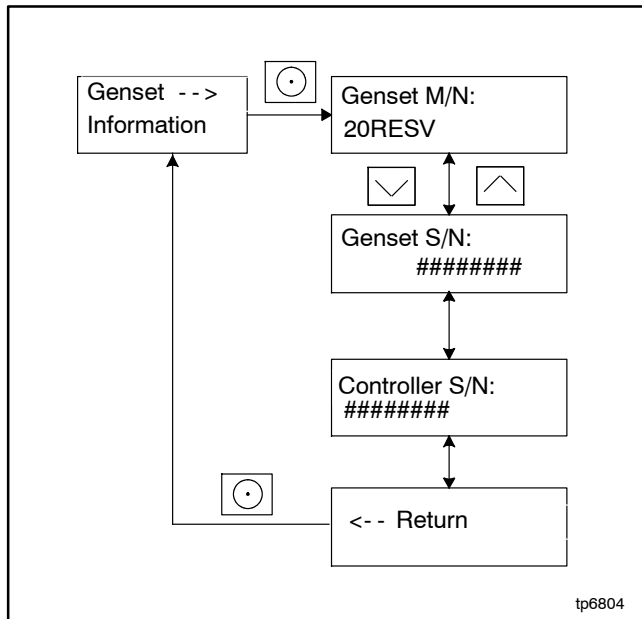


Figure 3-13 Generator Set Information Menu

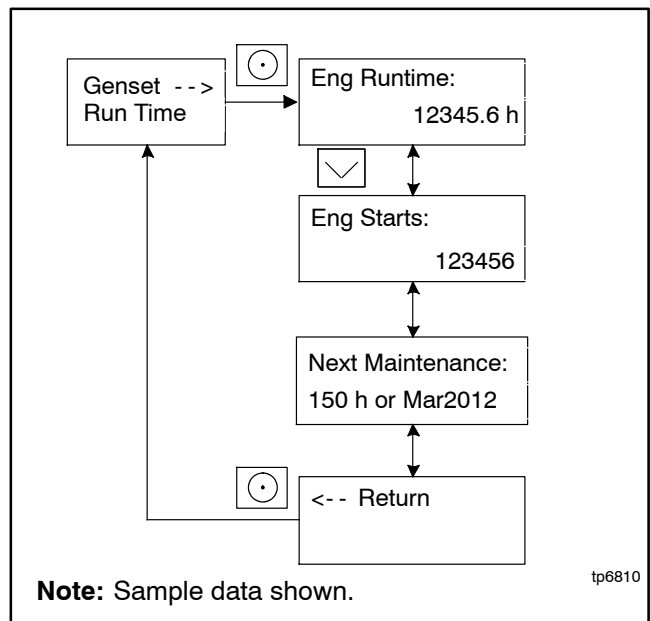
### 3.13 Genset Run Time Menu

The data shown in Figure 3-14 are displayed. No changes are allowed from this menu.

Eng Runtime displays the total number of hours that the generator set engine has run. The runtime is not resettable.

The Next Maintenance menu shows the number of hours of generator set operation until maintenance is required. The estimated date for the next scheduled maintenance is also displayed. The maintenance reminder intervals are based on the engine manufacturer's recommendation for changing the oil. Refer to Section 4, Scheduled Maintenance, for maintenance instructions.

After changing the oil and performing other recommended maintenance, go to the Overview menu to reset the maintenance timer. See Section 4.2.5 for instructions to reset the maintenance timer.



**Note:** Sample data shown.

Figure 3-14 Generator Set Run Time Menu

### 3.14 Genset System Menu

The genset system menu displays the system information shown in Figure 3-15. Generator sets are factory set and should not require changes to the system settings in the field.

A Kohler authorized distributor or dealer can adjust these settings, if necessary. If the generator set is reconnected to a different voltage or the system settings require adjustment for some other reason, see Section 3.5 for instructions to enable editing and change the system settings.

**Note:** Use caution when navigating the controller menus. In some menus, pressing the Select button can enable editing of the controller settings. Changing the settings to incorrect values can adversely affect generator set operation or render the unit inoperable.

#### Voltage Regulator (VR) Voltage Adj

The generator set voltage is factory set and typically does not require adjustment in the field. If voltage adjustment is required, contact a Kohler authorized distributor or dealer for service. Refer to the generator set Installation Manual for instructions to adjust the voltage.

#### Fuel Type

The fuel type, LP or natural gas, is shown. Do not change the fuel type in this menu unless the generator fuel system has been converted by an authorized distributor or dealer.

#### Setting the Exerciser

Use the Genset System menus to set the generator set exerciser. Refer to Section 2.4 for instructions to set the exerciser and for more information about exercising the generator set.

After a scheduled exercise run, the Next Exercise time and date will be updated automatically based on the Exercise Frequency setting.

#### Adjusting the Display Contrast

To adjust the display contrast, use the down arrow button to step to the Contrast menu. Press the Select button, and then use the up and down arrow buttons to adjust the contrast. Press the Select button to save the contrast setting.

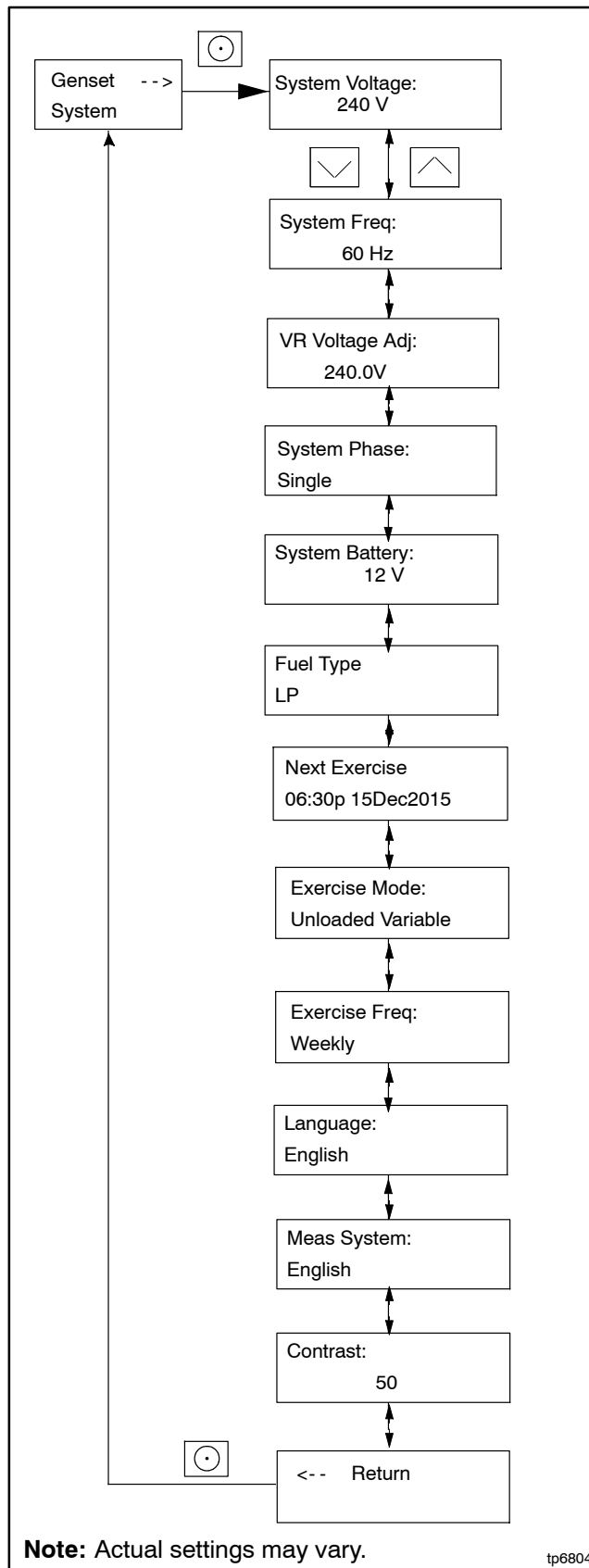


Figure 3-15 Genset System Menu



### 3.15 ATS Status Menu

ATS menus appear if a Model RXT transfer switch is connected to the generator set. If no transfer switch is connected, or another model ATS is connected to the engine start connections, Remote ATS is displayed on the ATS Status screen.

The ATS Status menu displays Model RXT transfer switch and source information.

The voltage shown in these menus can be calibrated. Follow the safety precautions at the beginning of this manual. Use a voltmeter to measure the line-to-line voltage and follow the instructions in Figure 3-16 to calibrate the voltage readings.

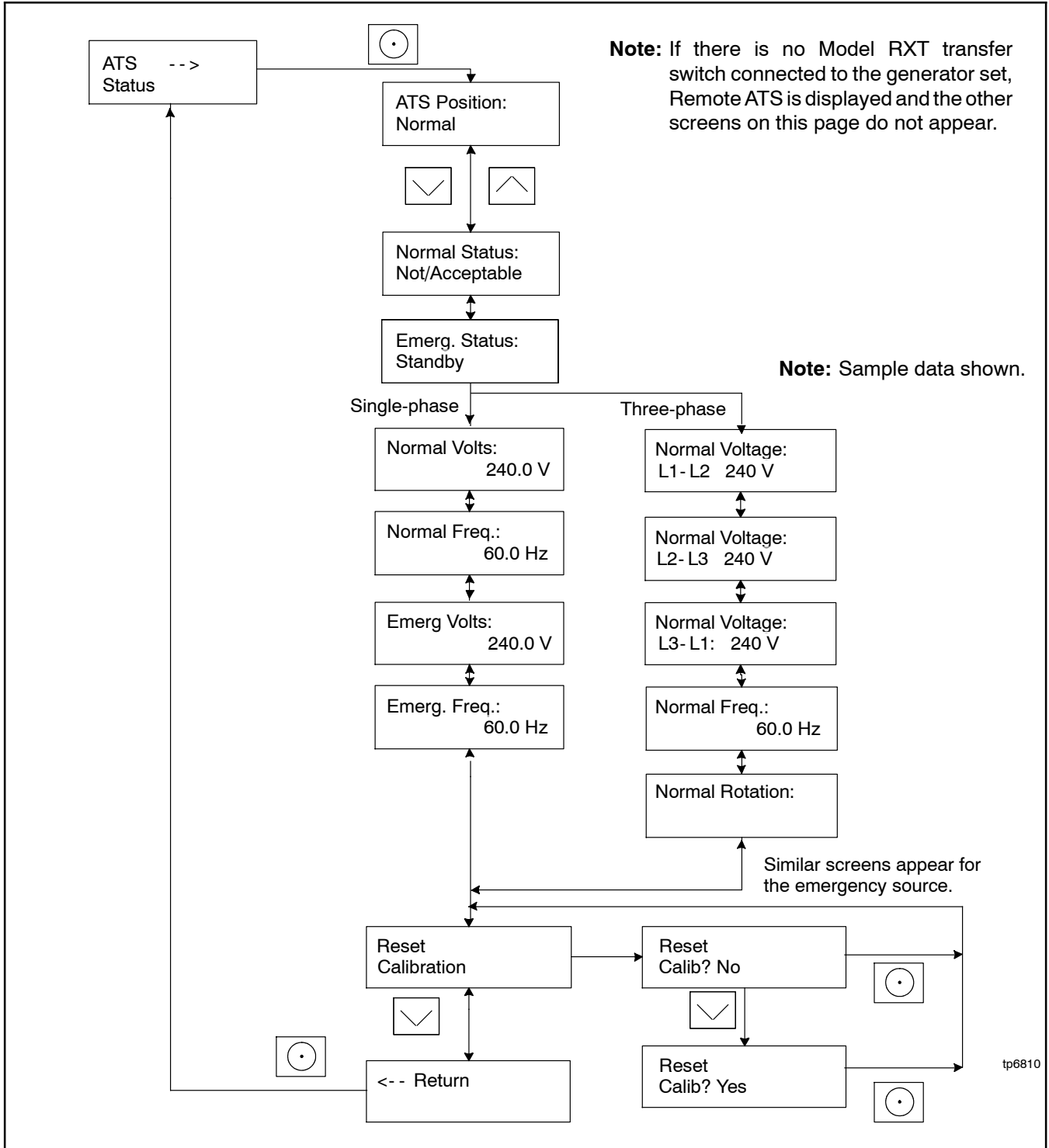


Figure 3-16 ATS Status Menu, with Calibration

### 3.16 ATS Configuration Menu

**Note:** The ATS Configuration menu appears only if a Model RXT transfer switch is connected.

Use the ATS Configuration submenu to check the Model RXT transfer switch system settings and time delays, and change the settings, if necessary.

#### Changing ATS Configuration Settings

To enable editing, press the select button. The value flashes to indicate that it can be changed. Press the up and down arrow buttons to change the value. Press the Select button to save the value shown.

Use the up and down arrow buttons to move to the next value to be changed. Repeat the adjustment process until all values are correct.

Press the down arrow until Return is displayed. Press the select button to return to the main menu.

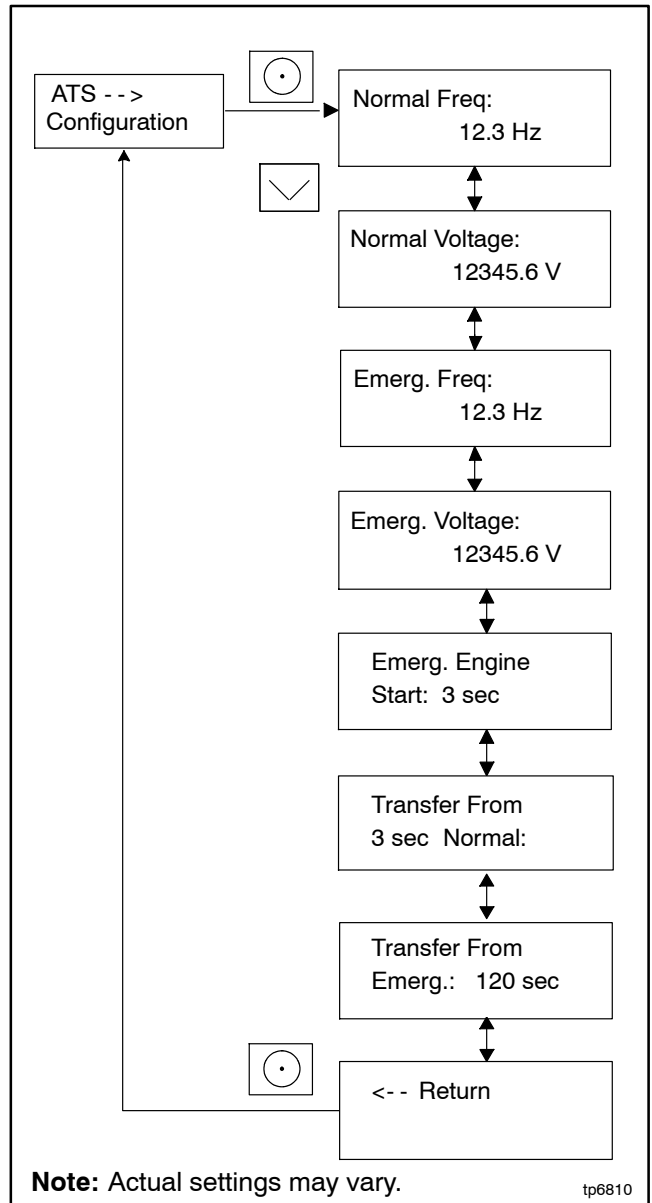


Figure 3-17 ATS Configuration Menu

### 3.17 Date and Time Menu

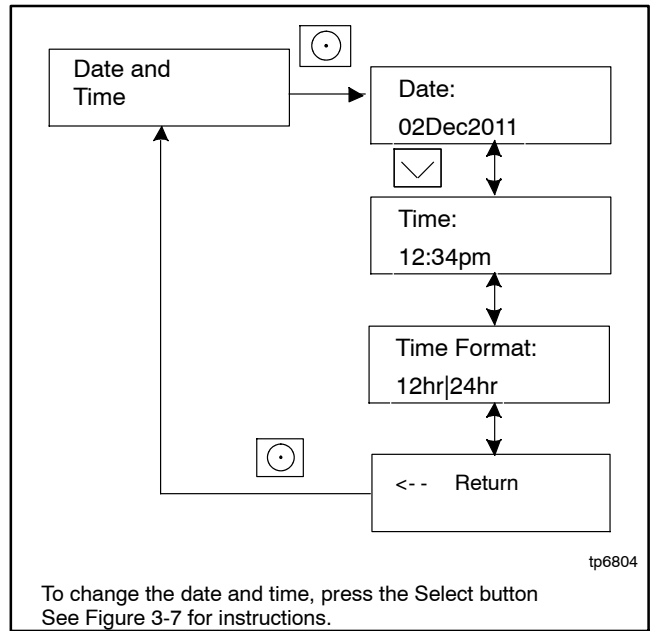
The date and time will typically be set at controller power-up. To change the date, time, or time format (12 hour or 24 hour), use the Date and Time menu. See Figure 3-18.

### 3.18 Networking Information Menus

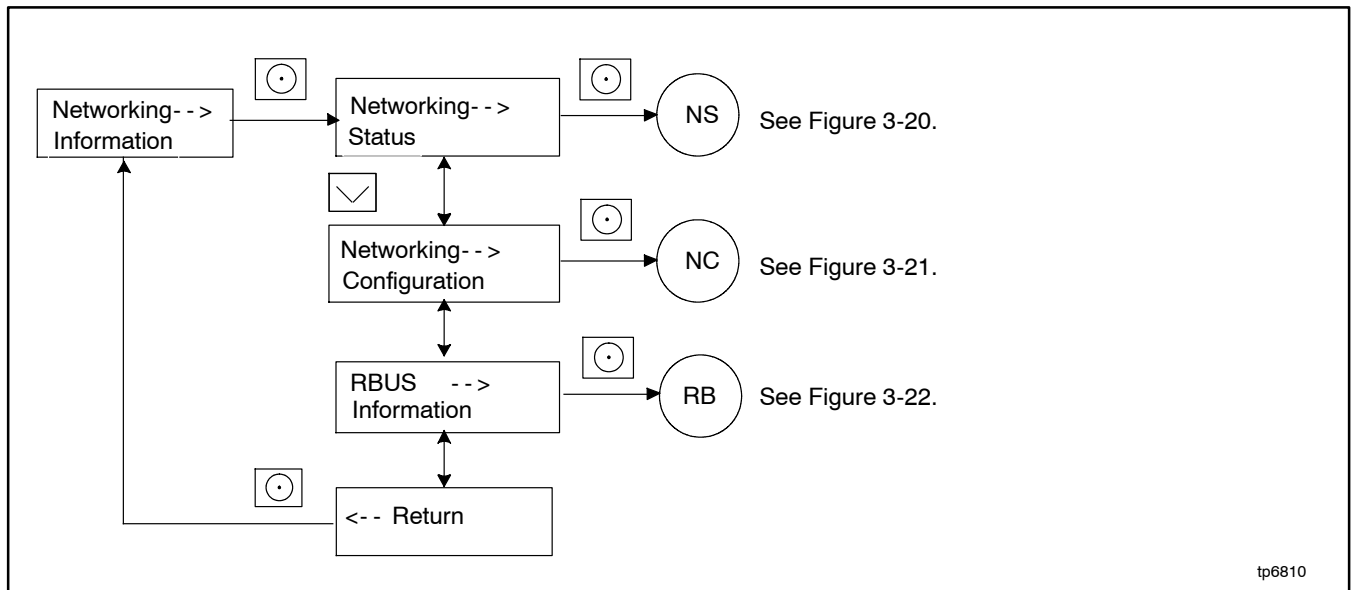
Use the networking menus to view and adjust communication settings for systems with remote RBUS devices such as a PIM or load shed kit, and for systems that use the Kohler® OnCue® Plus Generator Management System.

RBUS is a proprietary RS-485 communications protocol.

The Networking Information menu leads to submenus for network and RBUS communication settings.



**Figure 3-18** Date and Time Menu



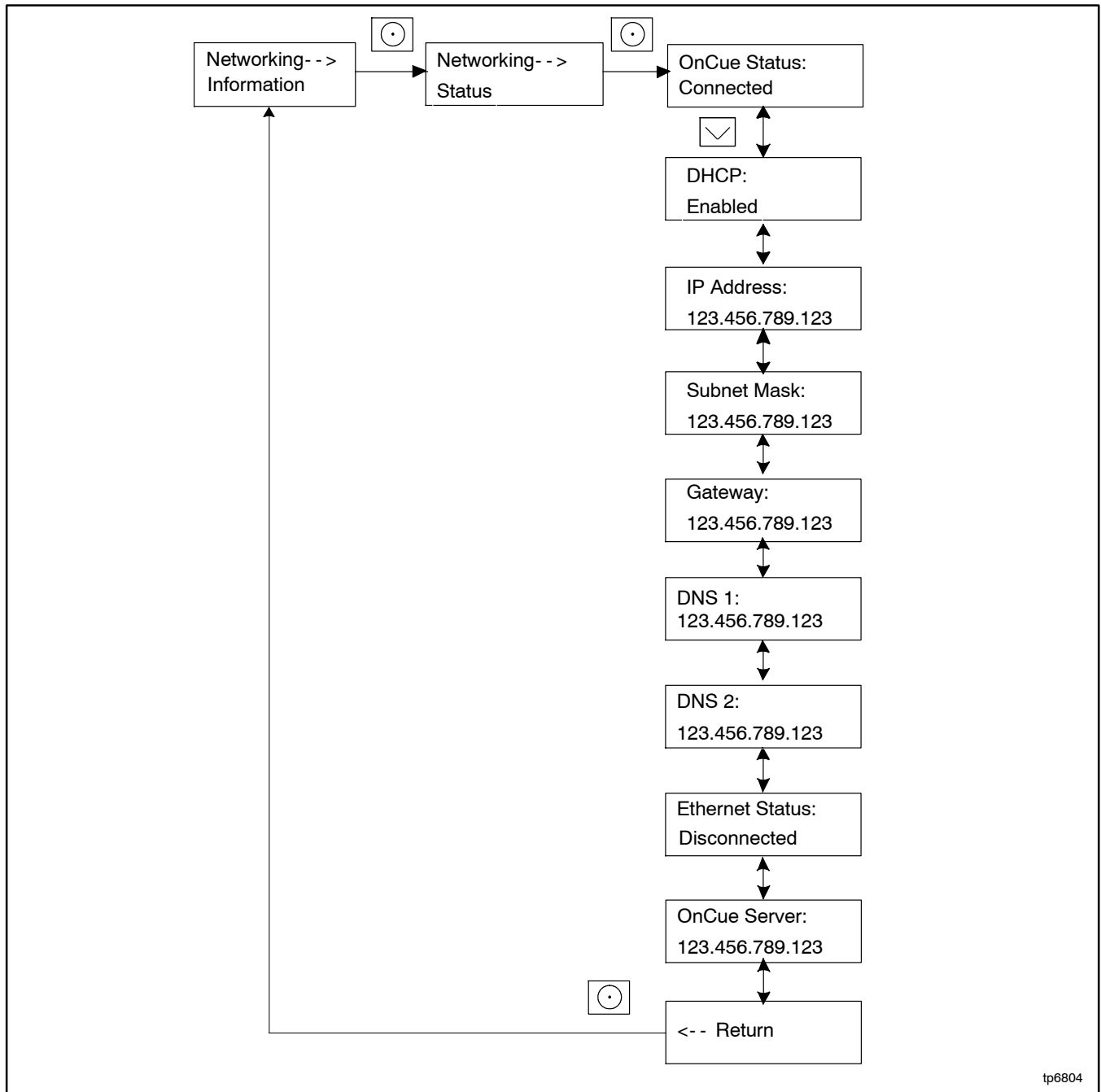
**Figure 3-19** Networking Information Menu

### 3.18.1 Networking Status Submenu

The Networking Status submenu contains settings for OnCue® Plus. See the OnCue Plus Software Operation Manual for information about the appropriate network settings for OnCue Plus. Changes to these settings are not typically required.

If DHCP is enabled, IP parameters are not displayed. If DHCP is disabled (i.e., if a static IP address is used), the IP parameters are displayed.

To enable or disable DHCP and change the IP settings, go to the Networking Configuration menu. See Section 3.18.2.



tp6804

Figure 3-20 Network Status Submenu

### 3.18.2 Networking Configuration Submenu (OnCue Plus Password)

The Networking Configuration menu includes settings used for communication with the Kohler® OnCue® Plus Generator Management System.

#### Password

**Note:** Use the OnCue password shown on the controller display for OnCue Plus applications.

For the initial OnCue Plus setup, you will be required to reset the OnCue password on the RDC2 controller, and then enter it into the OnCue Plus software. To reset the password, follow the instructions in Figure 3-21.

**Note:** The password is displayed for only 10 seconds. Be sure to write down the password and serial number.

A new password is generated each time the reset password procedure is performed. If the password is

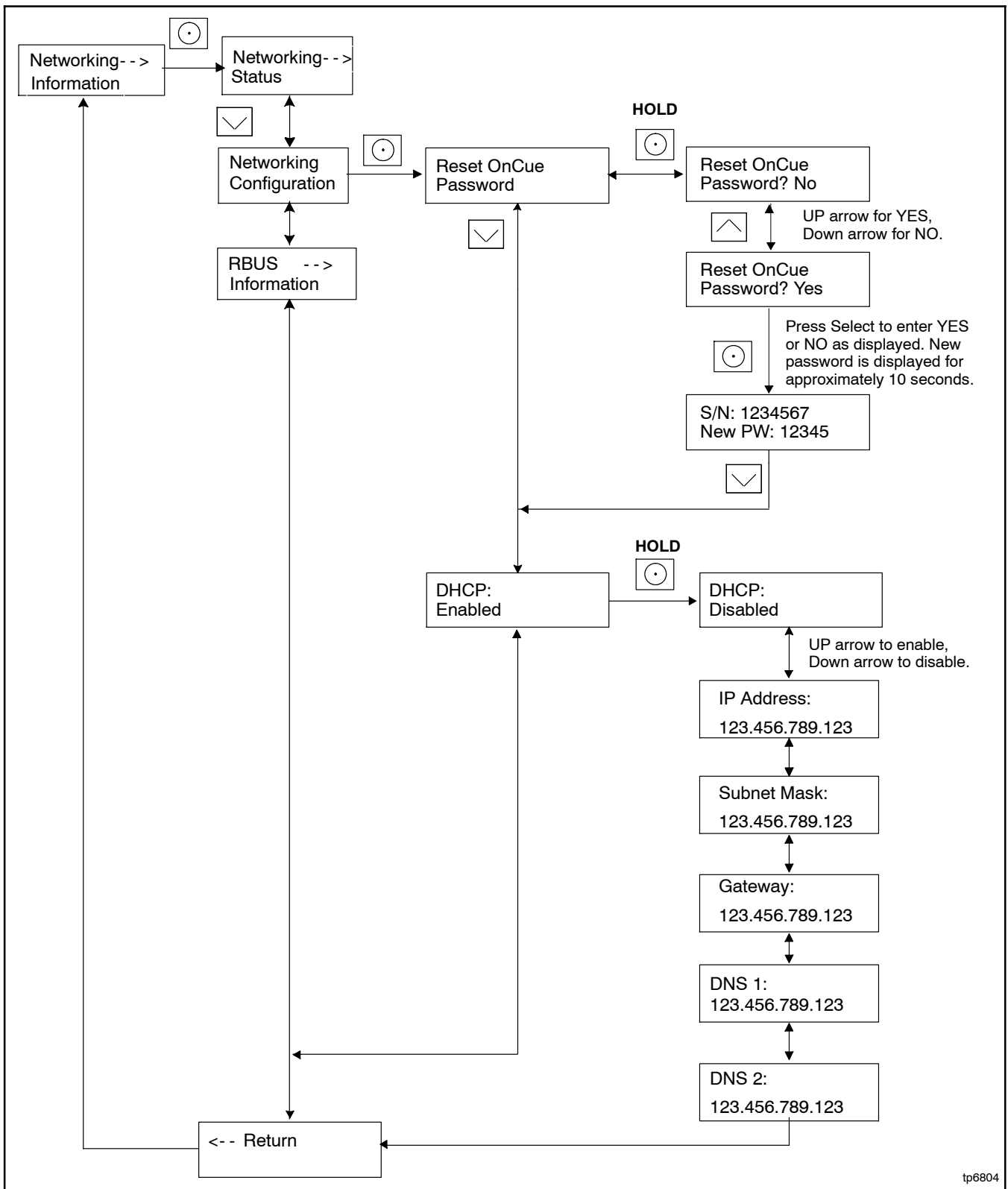
reset after the OnCue Plus system has been set up, the connection will be lost. Disconnect the battery power to the controller, wait a minute, then reconnect power.

#### DHCP Submenu

For most applications, the Dynamic Host Configuration Protocol (DHCP) is enabled and the IP settings cannot be changed from the controller keypad. If DHCP is enabled, IP parameters are not displayed.

If DHCP is disabled (i.e., if a static IP address is required), then the IP parameters can be modified. For applications that require static IP addresses, press and hold the select button to enable editing, disable DHCP, and then step to the next parameters and enter the information.

If an error occurs while setting a parameter, an error message is displayed and then the controller exits the edit mode. Previous settings are preserved.



tp6804

**Figure 3-21** Network Configuration Submenu

### 3.18.3 RBUS Information

The RBUS Information menu contains settings for remote modules that communicate with the RDC2 controller using RBUS protocol. This includes the following optional modules:

- Model RXT transfer switch
- Programmable Interface Module (PIM)
- Load Shed Kit or RXT combined interface/load management board

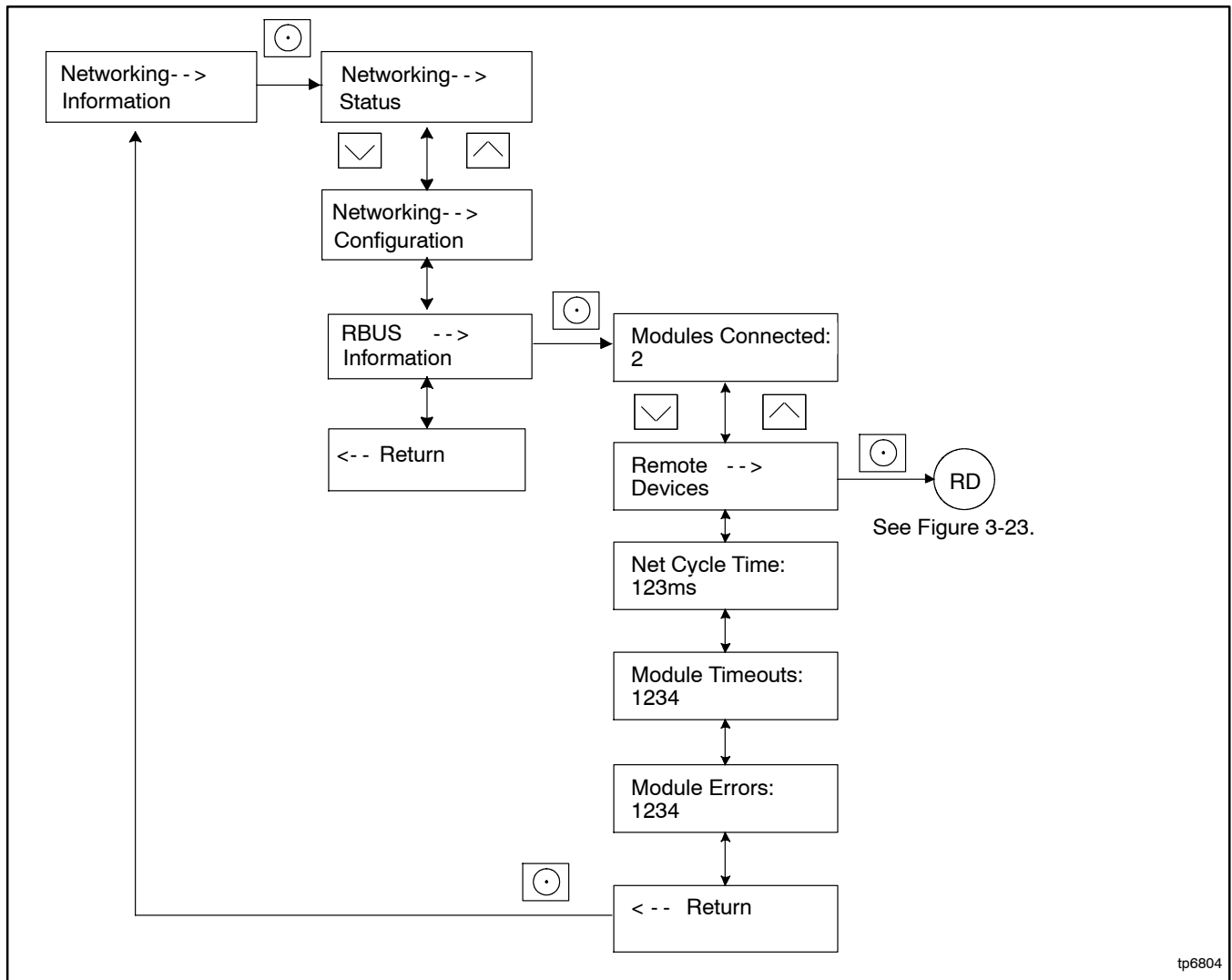


Figure 3-22 RBUS Information Submenu

tp6804

### 3.18.4 Remote Devices Submenu

Check the status of remote devices communicating through RBUS. Device types can include:

- Model RXT ATS
- Programmable Interface Module (PIM)
- Load Shed Kit or RXT combined interface/load management board

The serial numbers for the PIM or load shed kit are printed on the circuit boards inside the enclosures.

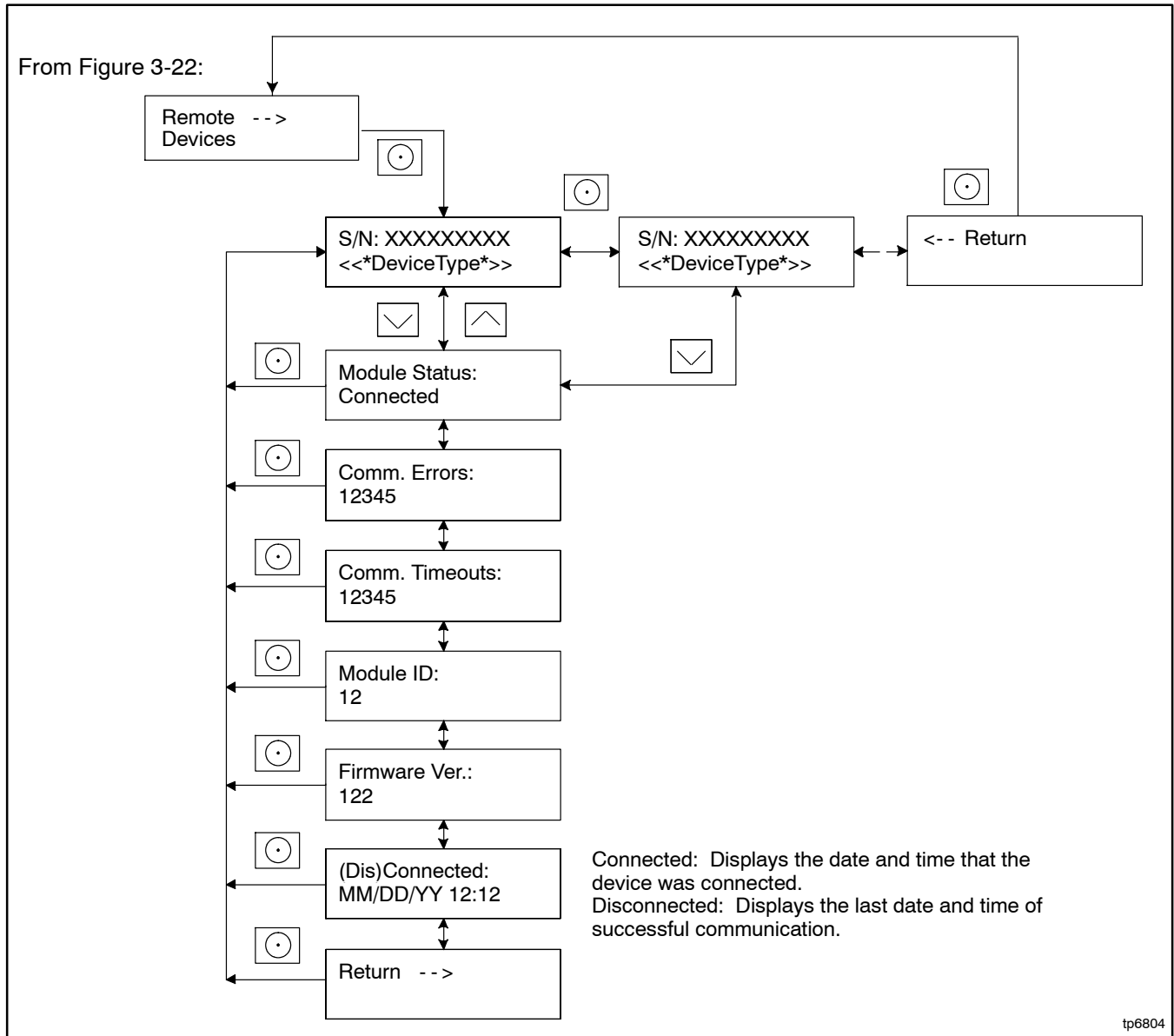


Figure 3-23 Remote Devices Submenu

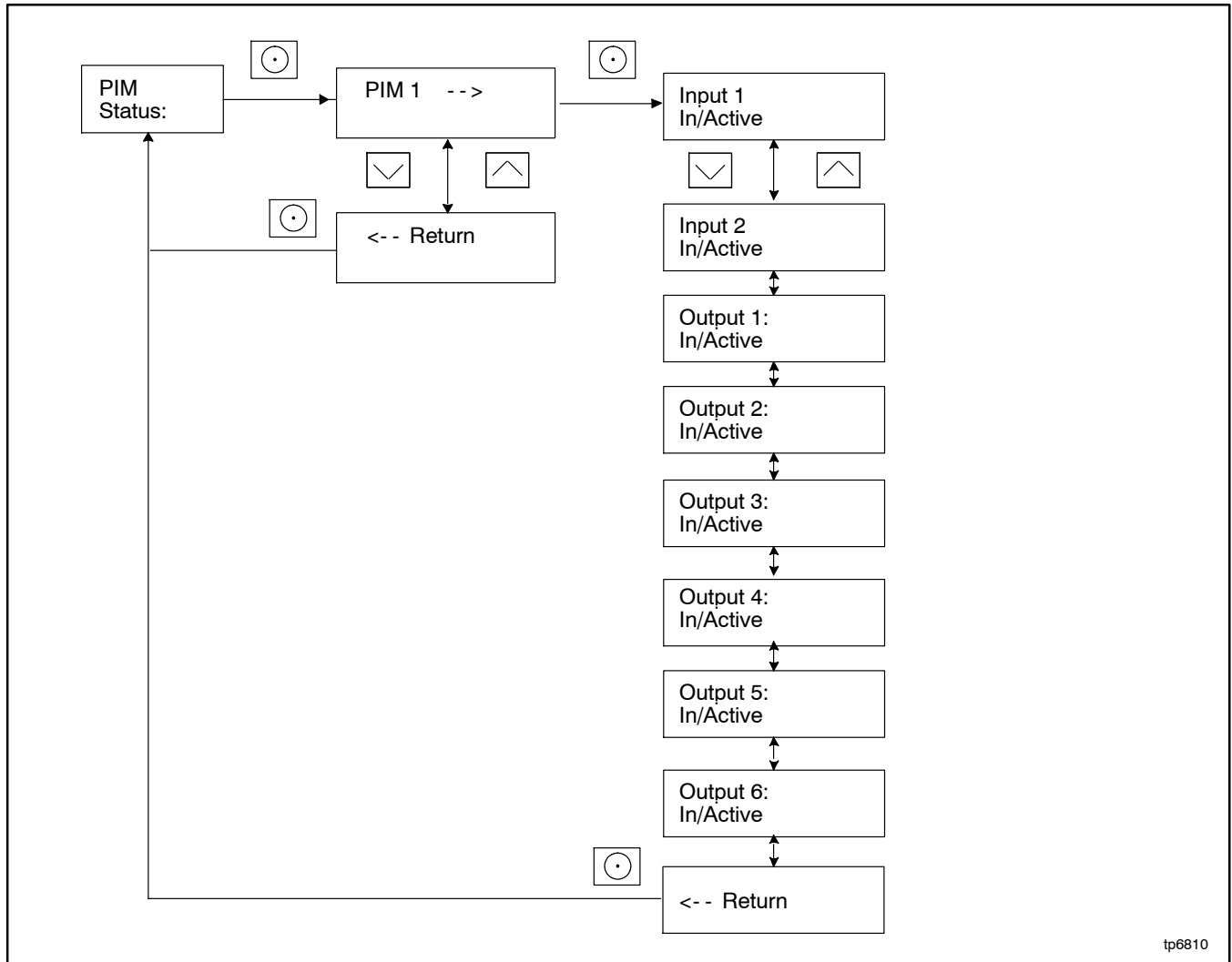


### 3.19 Programmable Interface Module (PIM) Status Menu

The PIM status menu displays the status of inputs and outputs connected to the programmable interface module (PIM). This menu appears only if a PIM is connected. This is a status display menu only. Input and output settings cannot be changed from the RDC2 controller's user interface.

A personal computer running Kohler® SiteTech™ software is required to change the input and output settings. Contact an authorized distributor or dealer for service.

The Kohler® OnCue® Plus Management System can be used to turn outputs on and off. See the OnCue® Plus Software Operation Manual for instructions.



tp6810

Figure 3-24 Programmable Interface Module (PIM) Status Menu

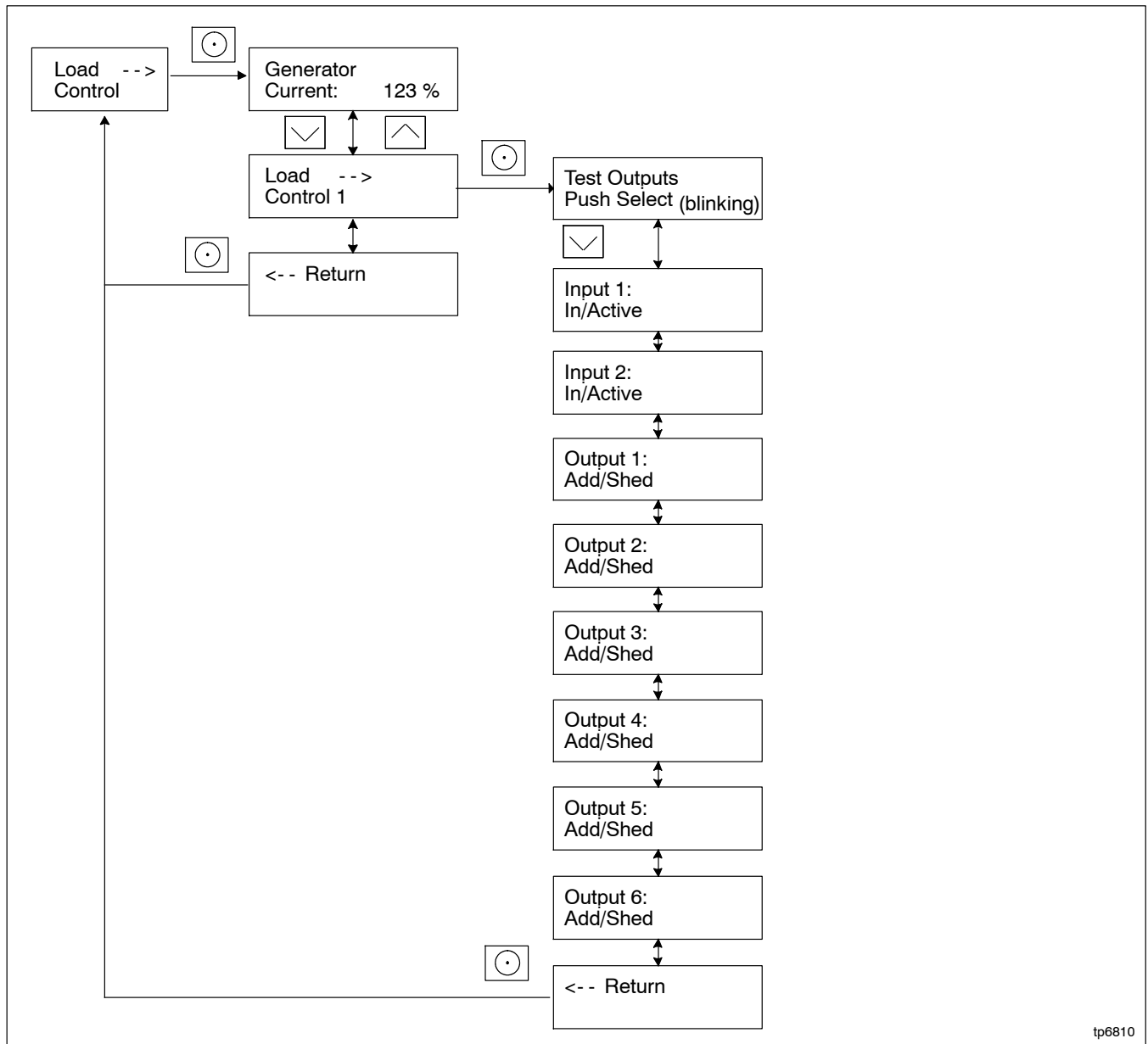
### 3.20 Load Control Menus

The Load Control menu displays the status of the load management inputs and outputs, and allows a test of the load management output relays. This menu appears only if a load management device is connected.

Generator current is displayed as a percent of the maximum generator capacity. The load management device adds and sheds loads based on the generator current.

The test function cycles the relays in the order of their priority. For detailed information about load management operation, refer to TT-1609, provided with the load shed kit, or TP-6807, RXT Transfer Switch Operation and Installation Manual.

**Note:** Load shed kits are not available with the transfer switch supplied with models 8RESVL, 10RESVL, 12RESVL.



tp6810

**Figure 3-25** Load Control Status Menu

## 3.21 Event Log

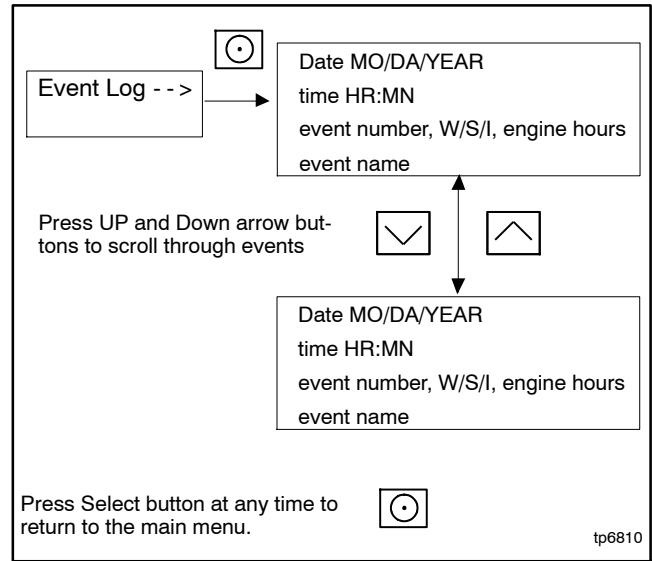
The event log displays up to 1000 controller faults and notices, starting with the most recent event. Events are numbered 1- 1000, with 1 being the most recent. Each event is displayed with the date and time of the event, the number of the event, a code to indicate whether the event was a warning (W), shutdown (S), or informational notice (I), the engine hours at the time of the event, and the event description.

The time and date for notices (I) are not stored in the controller.

### Procedure to View Event History

1. Press Select to enter the main menu.
2. Press the down arrow to step down to the event log.
3. Press Select to display the most recent event.
4. Press the down arrow to step to the next event.
5. Use the up and down arrow buttons to view events.
6. Press the Select button to exit the event log.

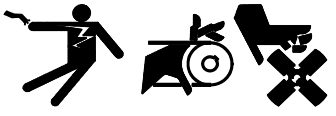
To stop viewing the event history before the last event, press the select button to return to the main menu.




**Figure 3-26** Event Log

# Notes

## Section 4 Scheduled Maintenance

<b>⚠ WARNING</b>

<b>Accidental starting. Can cause severe injury or death.</b>  Disconnect the battery cables before working on the generator set. Remove the negative (-) lead first when disconnecting the battery. Reconnect the negative (-) lead last when reconnecting the battery.


**Disabling the generator set. Accidental starting can cause severe injury or death.** Before working on the generator set or equipment connected to the set, disable the generator set as follows: (1) Press the generator set off/reset button to shut down the generator set. (2) Disconnect the power to the battery charger, if equipped. (3) Remove the battery cables, negative (-) lead first. Reconnect the negative (-) lead last when reconnecting the battery. Follow these precautions to prevent the starting of the generator set by the remote start/stop switch.


<b>⚠ WARNING</b>

<b>Hot engine and exhaust system. Can cause severe injury or death.</b>  Do not work on the generator set until it cools.


**Servicing the alternator. Hot parts can cause severe injury or death.** Avoid touching the alternator field or exciter armature. When shorted, the alternator field and exciter armature become hot enough to cause severe burns.

**Servicing the exhaust system. Hot parts can cause severe injury or death.** Do not touch hot engine parts. The engine and exhaust system components become extremely hot during operation.

**Servicing the engine heater. Hot parts can cause minor personal injury or property damage.** Install the heater before connecting it to power. Operating the heater before installation can cause burns and component damage. Disconnect power to the heater and allow it to cool before servicing the heater or nearby parts.

<b>⚠ DANGER</b>

<b>Hazardous voltage. Will cause severe injury or death.</b>  This equipment must be installed and serviced by qualified electrical personnel.

<b>⚠ DANGER</b>

<b>Hazardous voltage. Moving parts. Will cause severe injury or death.</b>  Operate the generator set only when all guards and electrical enclosures are in place.

<b>⚠ WARNING</b>

<b>Risk of fire. Can cause severe injury or death.</b>  Do not smoke or permit flames or sparks near fuels or the fuel system.

**Servicing the air cleaner. A sudden backfire can cause severe injury or death.** Do not operate the generator set with the air cleaner removed.

**Servicing the fuel system. A flash fire can cause severe injury or death.** Do not smoke or permit flames or sparks near the carburetor, fuel line, fuel filter, fuel pump, or other potential sources of spilled fuels or fuel vapors. Catch fuels in an approved container when removing the fuel line or carburetor.

**The fuel system. Explosive fuel vapors can cause severe injury or death.** Vaporized fuels are highly explosive. Use extreme care when handling and storing fuels. Store fuels in a well-ventilated area away from spark-producing equipment and out of the reach of children. Never add fuel to the tank while the engine is running because spilled fuel may ignite on contact with hot parts or from sparks. Do not smoke or permit flames or sparks to occur near sources of spilled fuel or fuel vapors. Keep the fuel lines and connections tight and in good condition. Do not replace flexible fuel lines with rigid lines. Use flexible sections to avoid fuel line breakage caused by vibration. Do not operate the generator set in the presence of fuel leaks, fuel accumulation, or sparks. Repair fuel systems before resuming generator set operation.

**Gas fuel leaks. Explosive fuel vapors can cause severe injury or death.** Fuel leakage can cause an explosion. Check the LPG vapor or natural gas fuel system for leakage by using a soap and water solution with the fuel system test pressurized to 6-8 ounces per square inch (10-14 inches water column). Do not use a soap solution containing either ammonia or chlorine because both prevent bubble formation. A successful test depends on the ability of the solution to bubble.

**LPG liquid withdrawal fuel leaks. Explosive fuel vapors can cause severe injury or death.** Fuel leakage can cause an explosion. Check the LPG liquid withdrawal fuel system for leakage by using a soap and water solution with the fuel system test pressurized to at least 90 psi (621 kPa). Do not use a soap solution containing either ammonia or chlorine because both prevent bubble formation. A successful test depends on the ability of the solution to bubble.

See the Safety Precautions and Instructions at the beginning of this manual before attempting to service, repair, or operate the generator set. Have an authorized distributor/dealer perform generator set service.

**Routine Maintenance.** Refer to the following generator set service schedule, the engine service schedule, and the runtime hours displayed on the generator set controller to determine when to schedule routine maintenance. Service the generator set more frequently if it is subject to extreme weather, long operating hours, or dusty or dirty conditions.

**Maintenance Reminders.** The controller displays a reminder message every 100 hours of engine run time. Change the oil and perform other maintenance tasks listed on the service schedule. Then reset the reminder. See Section 4.2.5 for instructions to reset the maintenance reminder.

**Service Schedule.** Perform maintenance on each item in the service schedule at the designated interval for the life of the generator set.

**Tools.** Tools and instruments used to perform some maintenance items are not generally available to the generator set owner. Therefore, have service performed by an authorized distributor/dealer.

## 4.1 Scheduled Maintenance

Refer to the following service schedules and the runtime hours displayed on the controller display to schedule routine maintenance. Intervals are shown in hours of operation and/or time intervals (i.e. weekly, monthly, quarterly, etc.) Have an authorized distributor/dealer service the generator set at the designated intervals in the service schedule for the life of the generator set. Service units subject to extreme weather, long operating hours, or dusty or dirty conditions more frequently.

Contact an authorized distributor/dealer for parts.

## 4.1.1 Service Schedule

System Component or Procedure	See Section	Procedure					Frequency	
		Visually Inspect	Check	Change	Clean	Test		
<b>Fuel</b>								
Flexible lines and connections		X		R			Quarterly	
Main tank supply level			X				Weekly	
Fuel piping		X					Yearly	
<b>Lubrication</b>								
	4.2							
Oil level		X	X				8 hours or before use	
Crankcase breather hose		X					Yearly or 500 hours	
Change oil				X			Yearly or 100 hours	
Replace filter				X			Yearly or 100 hours	
<b>Cooling</b>								
	4.5							
Air ducts, louvers			X		X		Yearly	
<b>Exhaust Line</b>								
	4.6							
Leakage		X	X				Weekly	
Insulation, fire hazards		X					Yearly	
Obstructions or combustible materials near exhaust outlet		X					Weekly	
<b>DC Electrical System</b>								
	4.7							
Battery charger operation, charge rate (if equipped)		X					Monthly	
Remove corrosion, clean and dry battery and rack		X			X		Yearly	
Clean and tighten battery terminals and inspect boots		X	X				Yearly	
Battery electrolyte level and specific gravity *			X				Yearly	
<b>AC Electrical System</b>								
Tighten control and power wiring connections			X				Yearly	
Remote control system, if equipped						X	Monthly	
Visible wear or damage		X					Quarterly	
Wire abrasions where subject to motion		X	X				Six Months	
Wire-cable insulation condition		X					3 Years or 500 hours	
<b>Engine and Mounting</b>								
Visible wear or damage		X					Weekly	
Air cleaner service †	4.4		150	300			Yearly or hours shown	
Spark plugs (apply anti-seize lubricant for easy removal)	4.3			X			Yearly or 500 hours	
Have valve lash checked/adjusted, 8RESV(L)	Engine SM			D			100 hours	
Have valve lash checked/adjusted, 10/12RESV(L)	Engine SM			D			500 hours	
Replace stepper motor coupling and bushing				D			500 hours	
<b>Generator</b>								
Visible wear or damage		X					Quarterly	
Exercise generator set						X	Weekly	
Measure and record resistance readings of windings with insulation tester (Megger®, with SCR assembly or rectifier and load leads disconnected) *						D	3 Years	
<b>General Condition of Equipment</b>								
Evidence of vibration, leakage, excessive noise, temperature, or deterioration		X	X		X		Weekly	
Interior of sound enclosure		X			X		Quarterly	
* Not necessary for maintenance-free batteries.		X Action						
† Service more frequently under extremely dusty/dirty conditions.		D Authorized distributor/dealer only						
Megger® is a registered trademark of Biddle Instruments.		R Replace as necessary						

## 4.2 Lubrication System

See the service schedules in Section 4.1 for oil change and oil filter replacement intervals. See the service views in Section 1.9 for the oil drain, oil check, oil fill, and oil filter locations.

### 4.2.1 Low Oil Pressure Shutdown

The low oil pressure (LOP) shutdown feature protects the engine against internal damage if the oil pressure drops below a minimum pressure because of oil pump failure or other malfunction.

**Note:** The LOP shutdown feature does not protect against damage caused by operating when the oil level is low; it is not a low oil level shutdown. Check the oil level regularly, and add oil as needed.

### 4.2.2 Oil Check

The generator set is shipped with oil. Before operating the generator set, check the engine oil in the crankcase.

To check the oil level, shut down the generator set and wait several minutes. Remove the dipstick and wipe the end clean, reinsert, and remove. See Figure 4-1. Maintain the oil level between the Add and Full marks on the dipstick. Add 5W-30 synthetic oil when the oil level is low.

Check the oil level before each use. For extended operation, check the oil level every 8 hours. Do not check the oil level when the generator set is running.

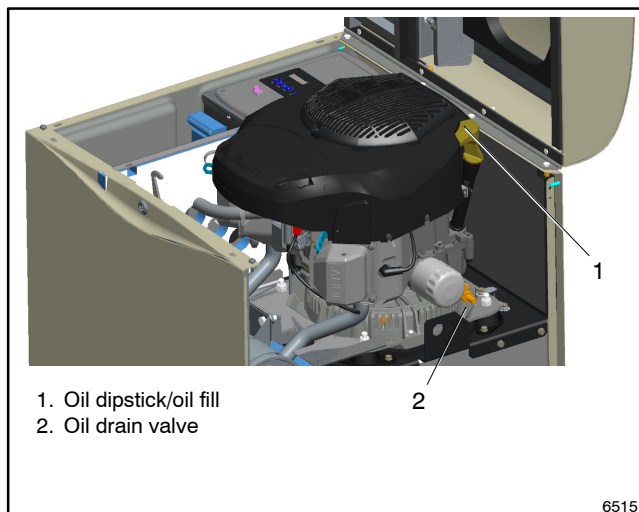
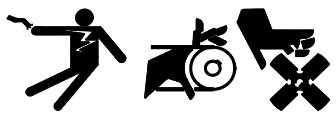


Figure 4-1 Oil Check (typical)


### 4.2.3 Engine Oil Recommendation

Use 5W-30 API (American Petroleum Institute) Service Class SG, SH, or SJ synthetic oil. Synthetic oil oxidizes and thickens less than other oils and leaves the engine intake valves and pistons cleaner.

### 4.2.4 Oil Change Procedure

<b>⚠ WARNING</b>

<b>Accidental starting. Can cause severe injury or death.</b>
Disconnect the battery cables before working on the generator set. Remove the negative (-) lead first when disconnecting the battery. Reconnect the negative (-) lead last when reconnecting the battery.

**Disabling the generator set. Accidental starting can cause severe injury or death.** Before working on the generator set or equipment connected to the set, disable the generator set as follows: (1) Press the generator set off/reset button to shut down the generator set. (2) Disconnect the power to the battery charger, if equipped. (3) Remove the battery cables, negative (-) lead first. Reconnect the negative (-) lead last when reconnecting the battery. Follow these precautions to prevent the starting of the generator set by the remote start/stop switch.

<b>⚠ WARNING</b>

<b>Risk of fire. Can cause severe injury or death.</b>
Do not smoke or permit flames or sparks near fuels or the fuel system.

**Servicing the fuel system. A flash fire can cause severe injury or death.** Do not smoke or permit flames or sparks near the carburetor, fuel line, fuel filter, fuel pump, or other potential sources of spilled fuels or fuel vapors. Catch fuels in an approved container when removing the fuel line or carburetor.



**Note:** Dispose of all waste materials (engine oil, fuel, filter, etc.) in an environmentally safe manner.

**Note:** The oil change procedure requires the use of rags, a drain tube, and a funnel. Follow the instructions and use caution to prevent oil from spilling on or into the alternator.

### 1. Drain the oil.

- a. Press the OFF button on the generator set controller.
- b. Disconnect the utility power to the generator set.
- c. Disconnect the generator set engine starting battery, negative (-) lead first.
- d. Remove the side panel on the exhaust side of the enclosure.
- e. Clean the area around the dipstick and oil fill cap.
- f. To prevent oil from spilling into the alternator, completely cover the alternator with rags around the areas near the oil drain valve and oil filter.
- g. Insert a drain tube (3/8 in. inside diameter) onto the oil drain valve and place the end of the tube into a drain pan. The tube will reduce the potential for spilled oil.
- h. Open the oil drain valve on the engine.
- i. Remove the dipstick and oil fill cap. Allow time for the engine oil to drain completely.
- j. Close the oil drain valve and remove the oil drain tube.
- k. Replace the dipstick.

### 2. Replace the oil filter.

- a. Clean the area around the oil filter.
- b. Loosen the oil filter by rotating it counterclockwise with an oil filter wrench.
- c. As you remove the oil filter, tilt the filter upward to prevent oil from spilling.
- d. Clean the gasket sealing surface of the oil filter adapter.
- e. Apply a light coat of clean oil to the rubber seal of the new oil filter.

- f. Lightly thread the new oil filter by hand until you feel Resistance. Then, tighten the filter an additional 3/4 turn with an oil filter wrench.

### 3. Fill with oil.

**Note:** When the oil is drained, some oil remains in the engine. The amount of oil needed to refill the engine may be less than the capacity shown in Figure 4-2. Use the dipstick shown in Figure 4-1 to check the oil level during the fill. Do not fill past the full mark on the dipstick.

Generator Set Model	Oil Capacity, L (qt.)
8RESV/RESVL	1.5 (1.6)
10/12RESV/RESVL	1.9 (2.0)

**Figure 4-2** Engine Oil Capacity (new, dry engine)

- a. See Section 4.2.3 for the recommended oil type. To prevent spilling, use a funnel to add oil through the oil fill port. Use the dipstick to check the oil level before starting to add the final quart of oil. Fill the engine to the F mark on the dipstick.
- b. Reinstall the dipstick and the oil fill cap.
- c. Remove all rags near the alternator and oil drain valve.
- d. Reconnect the generator set engine starting battery, negative (-) lead last.
- e. Reconnect the utility power to the generator set.
- f. Press the RUN button on the generator set controller. The generator set will start.
- g. Run the generator set for a minute to allow the oil pressure to reach operating range.
- h. Stop the generator set, wait 1 minute, and then recheck the oil level. Add oil to bring the level up to the F mark on the dipstick.

### 4. Check for leaks.

- a. Check for oil leaks.
- b. Fix leaks and recheck the oil level.
- c. Reinstall the side panel.

### 5. Reset the maintenance timer on the controller.

## 4.2.5 Resetting the Maintenance Timer

### RDC2:

1. From the Overview menu, step down to the Genset Run Time menu.
2. Press the Select button and then step down to the Next Maintenance screen.
3. Press the Select button.
4. Press the Up arrow button so that "Reset Maint Timer? Yes" is displayed.
5. Press the Select button. **After about two minutes**, the new maintenance interval and date are displayed.

## 4.3 Spark Plugs

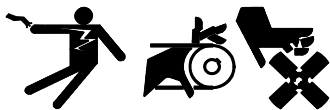
### ⚠ WARNING



**Airborne particles.**  
Can cause severe injury or blindness.

Wear protective goggles and clothing when using power tools, hand tools, or compressed air.

### ⚠ WARNING



**Accidental starting.**  
Can cause severe injury or death.

Disconnect the battery cables before working on the generator set. Remove the negative (-) lead first when disconnecting the battery. Reconnect the negative (-) lead last when reconnecting the battery.

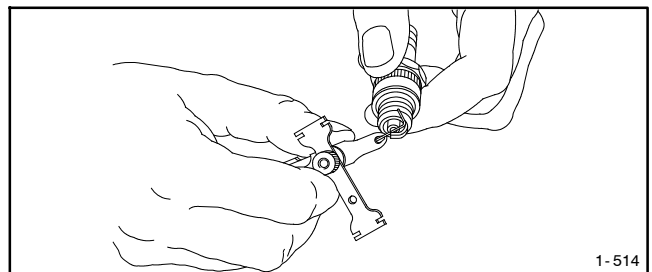
**Disabling the generator set. Accidental starting can cause severe injury or death.** Before working on the generator set or equipment connected to the set, disable the generator set as follows: (1) Press the generator set off/reset button to shut down the generator set. (2) Disconnect the power to the battery charger, if equipped. (3) Remove the battery cables, negative (-) lead first. Reconnect the negative (-) lead last when reconnecting the battery. Follow these precautions to prevent the starting of the generator set by the remote start/stop switch.

Reset the spark plug gap or replace the plugs with new plugs as necessary.

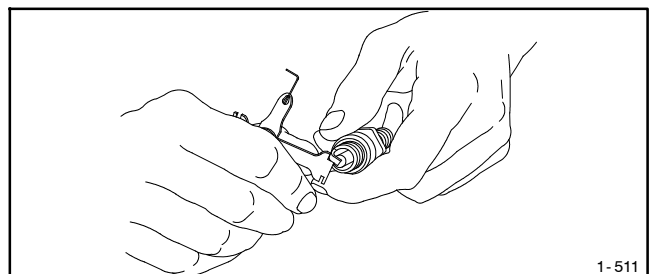
1. Clean the area around the base of the spark plug to keep dirt and debris out of the engine.
2. Remove the spark plug and check its condition. Replace the spark plug if it is worn or if its reuse is questionable.
3. Check the spark plug gap using a wire feeler gauge. See Figure 4-3 for the recommended spark plug gap. Adjust the gap by carefully bending the ground electrode. See Figure 4-4 and Figure 4-5.
4. For easy removal, apply a light coating of anti-seize lubricant to the cleaned spark plug threads. Wipe away any excess compound.
5. Reinstall the spark plug into the cylinder head. Torque the spark plug to 24.4-29.8 Nm (18-22 ft. lb.)

Generator Set Model	Spark Plug Gap
8/10/12RESV/RESVL	0.508 mm (0.020 in.)

**Figure 4-3** Spark Plug Gap

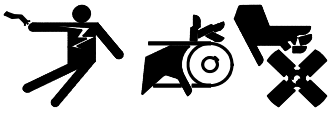


**Figure 4-4** Checking the Spark Plug Gap




**Figure 4-5** Adjusting the Spark Plug Gap

## 4.4 Air Cleaner Service

<b>⚠ WARNING</b>

<b>Accidental starting.</b> <b>Can cause severe injury or death.</b>
Disconnect the battery cables before working on the generator set. Remove the negative (-) lead first when disconnecting the battery. Reconnect the negative (-) lead last when reconnecting the battery.

**Disabling the generator set. Accidental starting can cause severe injury or death.** Before working on the generator set or equipment connected to the set, disable the generator set as follows: (1) Press the generator set off/reset button to shut down the generator set. (2) Disconnect the power to the battery charger, if equipped. (3) Remove the battery cables, negative (-) lead first. Reconnect the negative (-) lead last when reconnecting the battery. Follow these precautions to prevent the starting of the generator set by the remote start/stop switch.

<b>⚠ WARNING</b>

<b>Risk of fire.</b> <b>Can cause severe injury or death.</b>
Do not smoke or permit flames or sparks near fuels or the fuel system.

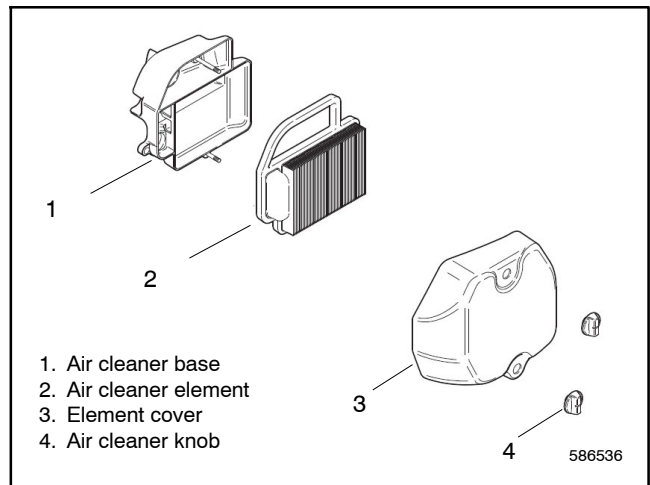
**Servicing the air cleaner. A sudden backfire can cause severe injury or death.** Do not operate the generator set with the air cleaner removed.

### 4.4.1 Air Cleaner, 8RESV/RESVL Models

The engine has a replaceable high-density paper air cleaner element. See Figure 4-6.

Check for a buildup of dirt and debris around the air cleaner system. Keep this area clean. Also check for loose or damaged components. Replace all bent or damaged air cleaner components.

**Note:** Operating the engine with loose or damaged air cleaner components could allow unfiltered air into the engine causing premature wear and failure.



**Figure 4-6** Air Cleaner Components

### Paper Element Service

Use the following procedure to replace the paper element at the intervals specified in the service schedule. Replace the paper element more often under extremely dusty or dirty conditions.

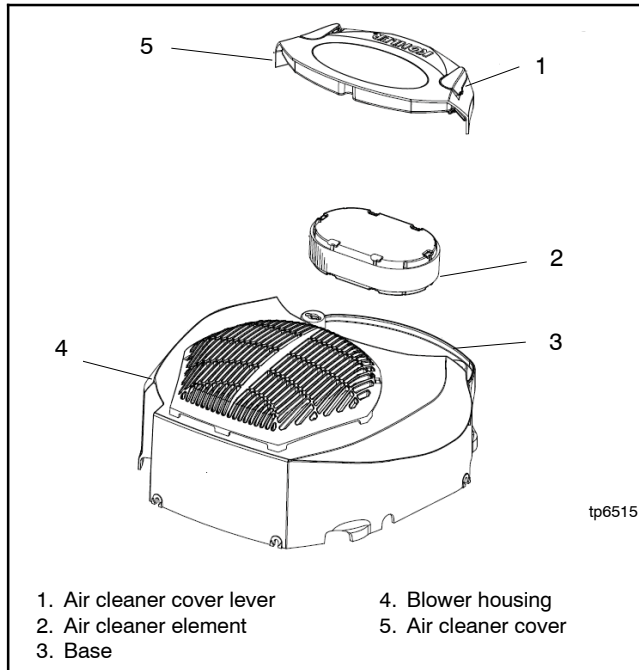
1. Press the OFF button on the generator set controller.
2. Disconnect the utility power to the generator set.
3. Disconnect the generator set engine starting battery, negative (-) lead first.
4. Loosen the cover retaining knobs and remove the cover.
5. Remove the paper element.

**Note:** Do not wash the paper element or clean it with pressurized air, as this will damage the element.

6. Replace the element if it is dirty, bent, or damaged.
7. Check the air cleaner base. Make sure it is secure and not bent or damaged. Also check the element cover for damage and fit. Replace all damaged air cleaner components. Remove any loose dirt or debris from the air cleaner base. Wipe the base carefully so that no dirt drops into the intake throat. Check the condition of the rubber seal on the air cleaner stud and replace the seal if necessary.
8. Reinstall the paper element and the air cleaner cover. Secure the cover with the cover retaining knobs.
9. Reconnect the utility power to the generator set.
10. Reconnect the generator set engine starting battery, negative (-) lead last.

#### 4.4.2 Air Cleaner, 10/12RESV/RESVL Models

The engine is equipped with a replaceable, high density paper air cleaner element. See Figure 4-7.



**Figure 4-7** Air Cleaner Components

Check the air cleaner daily or before starting the engine. Check for a buildup of dirt and debris around the air cleaner system. Keep this area clean. Also check for loose or damaged components. Replace all bent or damaged air cleaner components.

**Note:** Operating the engine with loose or damaged air cleaner components could allow unfiltered air into the engine causing premature wear and failure.

#### Paper Element Service

Replace the paper element at the intervals indicated in the service schedule. See Figure 4-7 for the air cleaner components.

1. Press the OFF button on the generator set controller.
2. Disconnect the utility power to the generator set.
3. Disconnect the generator set engine starting battery, negative (-) lead first.
4. Rotate the air cleaner cover levers outward to unlock cover; remove the air cleaner cover.
5. Remove the paper element from the base.

6. Do not wash the paper element or use pressurized air, as this will damage the element. Replace a dirty, bent, or damaged element. Handle new elements carefully; do not use if the sealing surfaces are bent or damaged.
7. When servicing the air cleaner, check the air cleaner base. Make sure it is secured and not bent or damaged. Also, check the element cover for damage or improper fit. Replace all damaged air cleaner components.

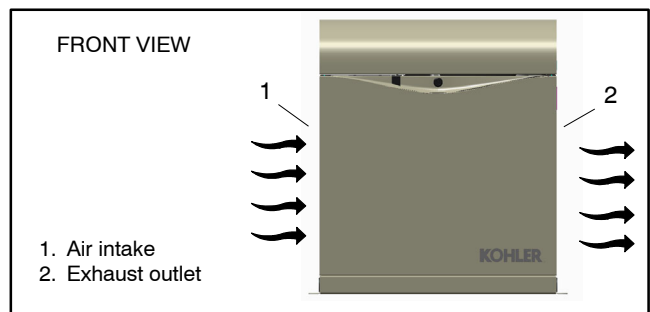
**Note:** If any loose dirt or debris fell on the air cleaner base when the element was removed, carefully remove it and wipe the base clean. Be careful that none of it drops into the intake throat.

8. Reinstall the paper element onto the air cleaner base. Make sure the element is flat and properly seated.
9. Position the air cleaner cover with levers outward over air cleaner; turn levers inward to lock.
10. When element replacement is necessary, order genuine Kohler parts.
11. Reconnect the power to the battery charger.
12. Reconnect the generator set engine starting battery, negative (-) lead last.

#### 4.5 Cooling System

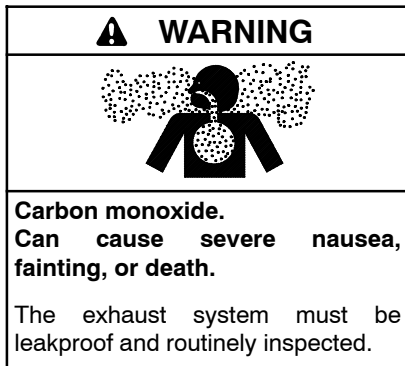
The engine fan draws cooling air through the openings in the sides and end near the battery. The alternator fan draws cooling air through openings on the side walls of the enclosure. The cooling air mixes with the engine exhaust and is discharged at the exhaust outlet. See the service view in Section 1.9 for air intake and exhaust locations. To prevent generator set damage caused by overheating, keep the housing cooling inlets and outlets clean and unobstructed at all times.

**Note:** Do not block the generator set cooling air inlets or mount other equipment above them. Overheating and severe generator damage may occur.



**Figure 4-8** Cooling Air Intake and Exhaust

## 4.6 Exhaust System



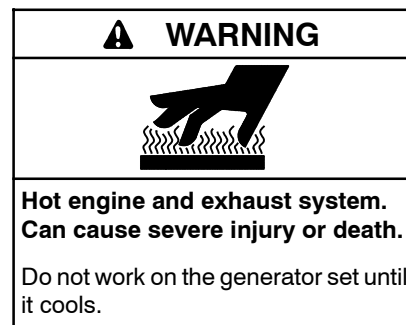
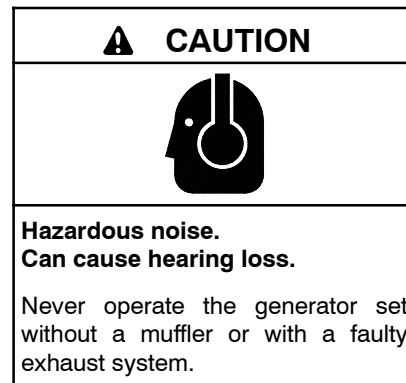
**Generator set operation. Carbon monoxide can cause severe nausea, fainting, or death.** Carbon monoxide is an odorless, colorless, tasteless, nonirritating gas that can cause death if inhaled for even a short time. Avoid breathing exhaust fumes when working on or near the generator set. Never operate the generator set inside a building. Never operate the generator set where exhaust gas could seep inside or be drawn into a potentially occupied building through windows, air intake vents, or other openings.

**Carbon monoxide detectors. Carbon monoxide can cause severe nausea, fainting, or death.** Install carbon monoxide detectors on each level of any building adjacent to the generator set. Locate the detectors to adequately warn the building's occupants of the presence of carbon monoxide. Keep the detectors operational at all times. Periodically test and replace the carbon monoxide detectors according to the manufacturer's instructions.

**Carbon monoxide symptoms. Carbon monoxide can cause severe nausea, fainting, or death.** Carbon monoxide is a poisonous gas present in exhaust gases. Carbon monoxide is an odorless, colorless, tasteless, nonirritating gas that can cause death if inhaled for even a short time. Carbon monoxide poisoning symptoms include but are not limited to the following:

- Light-headedness, dizziness
- Physical fatigue, weakness in joints and muscles
- Sleepiness, mental fatigue, inability to concentrate or speak clearly, blurred vision
- Stomachache, vomiting, nausea

If experiencing any of these symptoms and carbon monoxide poisoning is possible, seek fresh air immediately and remain active. Do not sit, lie down, or fall asleep. Alert others to the possibility of carbon monoxide poisoning. Seek medical attention if the condition of affected persons does not improve within minutes of breathing fresh air.



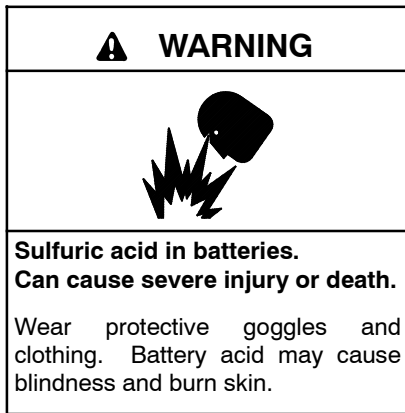
**Servicing the exhaust system. Hot parts can cause severe injury or death.** Do not touch hot engine parts. The engine and exhaust system components become extremely hot during operation.

Remove all combustible materials from the exhaust location. Combustible materials include building materials as well as natural surroundings. Keep dry field grass, foliage, and combustible landscaping material a minimum of 1.5 m (5 ft.) from the exhaust outlet.

Periodically inspect the exhaust system components for cracks, leaks, and corrosion.

- Check for corroded or broken metal parts and replace them as needed.
- Check that the exhaust outlet is clear.

## 4.7 Battery



**Battery electrolyte is a diluted sulfuric acid. Battery acid can cause severe injury or death.** Battery acid can cause blindness and burn skin. Always wear splashproof safety goggles, rubber gloves, and boots when servicing the battery. Do not open a sealed battery or mutilate the battery case. If battery acid splashes in the eyes or on the skin, immediately flush the affected area for 15 minutes with large quantities of clean water. Seek immediate medical aid in the case of eye contact. Never add acid to a battery after placing the battery in service, as this may result in hazardous spattering of battery acid.

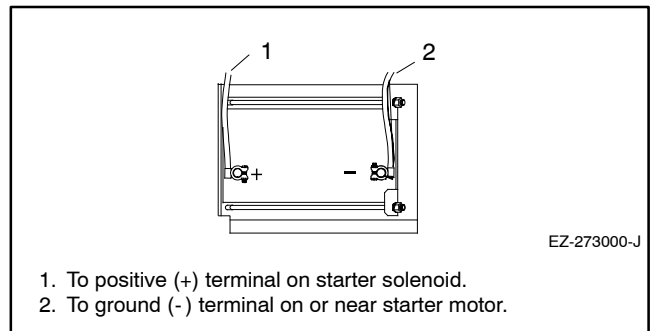
**Battery acid cleanup. Battery acid can cause severe injury or death.** Battery acid is electrically conductive and corrosive. Add 500 g (1 lb.) of bicarbonate of soda (baking soda) to a container with 4 L (1 gal.) of water and mix the neutralizing solution. Pour the neutralizing solution on the spilled battery acid and continue to add the neutralizing solution to the spilled battery acid until all evidence of a chemical reaction (foaming) has ceased. Flush the resulting liquid with water and dry the area.

**Battery gases. Explosion can cause severe injury or death.** Battery gases can cause an explosion. Do not smoke or permit flames or sparks to occur near a battery at any time, particularly when it is charging. Do not dispose of a battery in a fire. To prevent burns and sparks that could cause an explosion, avoid touching the battery terminals with tools or other metal objects. Remove all jewelry before servicing the equipment. Discharge static electricity from your body before touching batteries by first touching a grounded metal surface away from the battery. To avoid sparks, do not disturb the battery charger connections while the battery is charging. Always turn the battery charger off before disconnecting the battery connections. Ventilate the compartments containing batteries to prevent accumulation of explosive gases.

**Battery short circuits. Explosion can cause severe injury or death.** Short circuits can cause bodily injury and/or equipment damage. Disconnect the battery before generator set installation or maintenance. Remove all jewelry before servicing the equipment. Use tools with insulated handles. Remove the negative (-) lead first when disconnecting the battery. Reconnect the negative (-) lead last when reconnecting the battery. Never connect the negative (-) battery cable to the positive (+) connection terminal of the starter solenoid. Do not test the battery condition by shorting the terminals together.

Refer to this section for general battery information and maintenance. Also consult the battery manufacturer's instructions for battery maintenance.

All generator set models use a negative ground with a 12-volt engine electrical system. Consult the generator set nameplate for the engine electrical system voltage. Consult the generator spec sheet for battery capacity recommendations for replacement purposes. Wiring diagrams provide battery connection information. See Figure 4-9 for typical battery connections.



**Figure 4-9** 12-Volt Engine Electrical System Single Starter Motor, Typical Battery Connection

Clean the battery and cables and tighten battery terminals using the service schedule recommendations. To prevent corrosion, maintain tight, dry electrical connections at the battery terminals. To remove corrosion from battery terminals, disconnect the cables from the battery and scrub the terminals with a wire brush. Clean the battery and cables with a solution of baking soda and water. After cleaning, flush the battery and cables with clean water and wipe them with a dry, lint-free cloth.

After reconnecting the battery cables, coat the battery terminals with petroleum jelly, silicone grease, or other nonconductive grease.

**Note:** Ensure that the battery is positioned toward the front of the generator so it does not block the alternator air intake vent. See Figure 1-2.

### 4.7.1 Checking Electrolyte Level

Check the electrolyte level of batteries with filler caps monthly. Remove filler caps and verify that electrolyte level reaches bottom of filler holes. Refill as necessary with distilled water. DO NOT add fresh electrolyte. Tighten all filler caps. If water is added during freezing temperatures, run the generator set for 20- 30 minutes to mix the electrolyte and water to prevent battery damage from freezing.

### 4.7.2 Checking Specific Gravity

Use a battery hydrometer to check the specific gravity of the electrolyte in each battery cell. While holding the hydrometer vertically, read the number on the glass bulb at the top of the electrolyte level or the number adjacent to the pointer. If the hydrometer used does not have a correction table, use the correction factors in Figure 4-12. Determine specific gravity and electrolyte temperature of battery cells. Locate temperature in Figure 4-12 and adjust the specific gravity by the amount shown.

The battery is fully charged if the specific gravity is 1.260 at an electrolyte temperature of 80°F (26.7°C). The difference between specific gravities of each cell should not exceed ±0.01. Charge the battery if the specific gravity is below 1.215 at an electrolyte temperature of 80°F (26.7°C). See Figure 4-10.

Specific Gravity, Corrected to 80°F (26.7°C)	Battery Condition
Below 1.215	Needs charging
1.260	Fully charged

Figure 4-10 Specific Gravity Interpretation

Some battery testers have four or five beads in the test tube. Draw electrolyte into the tube as performed with the battery hydrometer described previously. Use the manufacturer’s instructions. Figure 4-11 interprets typical test results.

Number of Floating Beads	Battery Condition
5	Overcharged
4	Fully charged
3	Good charge
1 or 2	Low charge
0	Dead battery

Figure 4-11 Bead-Type Test Interpretation

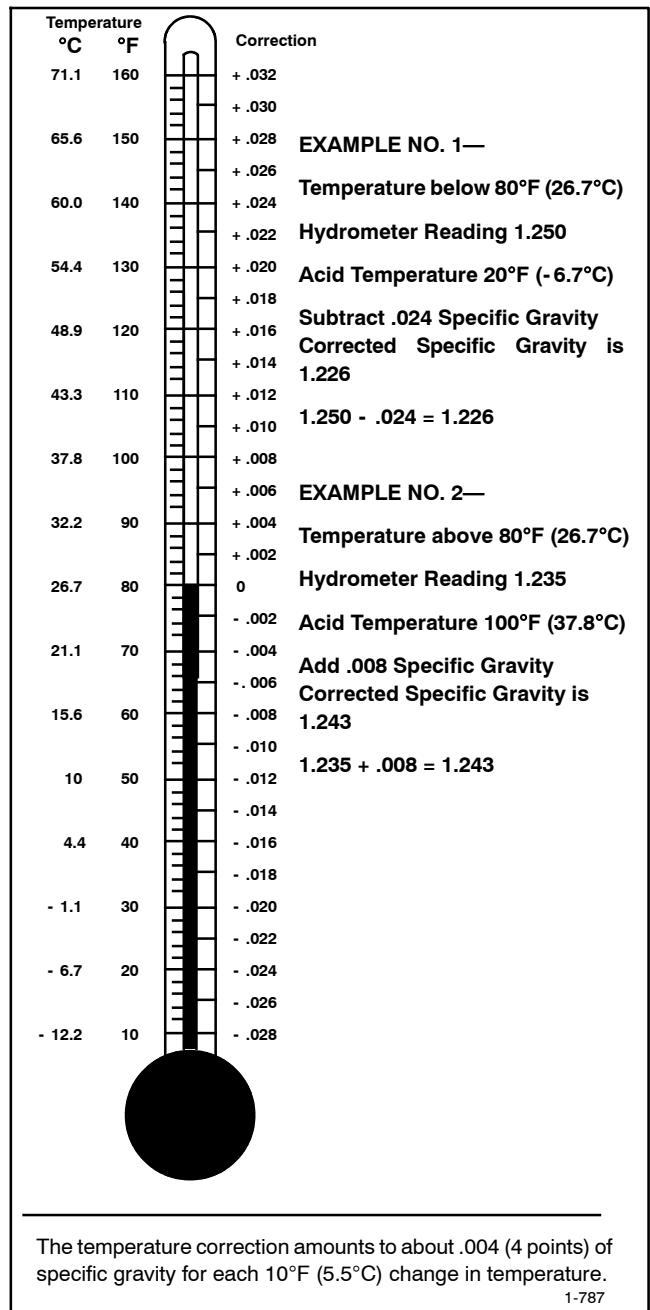


Figure 4-12 Specific Gravity Temperature Correction

## 4.8 Storage Procedure

Perform the following storage procedure before removing the generator set from service for three months or longer. Follow the engine manufacturer's recommendations for storage, if available.

**Note:** Run the generator set monthly whenever possible.

### 4.8.1 Lubricating System

1. Operate the generator set until it reaches operating temperature, or about 15 minutes.
2. Stop the generator set.
3. While the engine is still warm, drain the engine lubrication oil from the engine crankcase.
4. Refill engine crankcase with oil. See Section 4.2.3 for oil recommendations.
5. Run the generator set for a few minutes to distribute the clean oil.
6. Stop the generator set.

### 4.8.2 Fuel System

1. Start the generator set.
2. With the generator set running, shut off the gas supply.
3. Run the generator set until the engine stops.
4. Press the OFF button on the generator set controller.

### 4.8.3 Cylinder Lubrication

1. Remove the spark plugs.
2. Pour one tablespoon of engine oil into each spark plug hole. Install the spark plugs and *ground* the spark plug leads. *Do not connect the leads to the plugs.*
3. Crank the engine two or three revolutions to lubricate the cylinders.

### 4.8.4 Exterior Preparation

1. Clean the exterior surface of the generator set.
2. Seal all openings in the engine with nonabsorbent adhesive tape.
3. Mask all areas to be used for electrical contact.
4. Spread a light film of oil over unpainted metallic surfaces to prevent rust and corrosion.

### 4.8.5 Battery

Perform battery storage last.

1. Press the OFF button on the generator set controller.
2. Disconnect the battery, negative (-) lead first.
3. Clean the battery.
4. Place the battery in a warm, dry location.
5. Connect the battery to a float/equalize battery charger, or charge the battery monthly using a trickle charger. Follow the battery charger manufacturer's recommendations.



## Section 5 Troubleshooting

### 5.1 Introduction

Use the troubleshooting charts in this section to diagnose and correct common problems. First check for simple causes such as a dead engine starting battery, loose connections, or an open circuit breaker. The charts include a list of common problems, possible causes of the problem, and recommended corrective actions.

If the procedures in this manual do not explain how to correct the problem, contact an authorized Kohler distributor/dealer. Maintain a record of repairs and adjustments performed on the equipment. Use the record to help describe the problem and repairs or adjustments made to equipment.

### 5.2 USB Port

A USB port is located on the front of the controller. See Figure 1-2 for location. Use a USB cable with a mini-B connector to connect the controller to your personal computer (laptop).

Some controller settings can be adjusted using a laptop computer with Kohler® SiteTech™ software. SiteTech software is available to Kohler authorized distributors and dealers. See TP-6701, SiteTech™ Software Operation Manual, for more information.

### 5.3 Fault Messages

The controller displays fault messages to aid in troubleshooting. Selected fault messages and recommended checks are listed in Figure 2-3.

Identify and correct the cause of the fault condition. Then reset the controller after a fault shutdown. See Section 2.5.4.

### 5.4 Circuit Protection

If the generator set circuit breaker trips repeatedly, contact an authorized Kohler distributor/ dealer for service.

#### 5.4.1 Controller Internal Circuit Protection

The controller is equipped with internal circuit protection. A fault message, Accy PwrOver Warning or MainPwrOverL Shutdown, is displayed if this internal protection is activated. Press OFF to reset. Contact an authorized Kohler distributor/ dealer for service.

#### 5.4.2 Line Circuit Breaker

The line circuit breaker interrupts the generator output in the event of a fault in the wiring between the generator and the load. If the circuit breaker trips, reduce the load and switch the breaker back to the ON position.

#### 5.4.3 Auxiliary Winding Circuit Breaker

A resettable circuit breaker protects the alternator. The circuit breaker is located in the junction box area. See Figure 1-2.

## 5.5 Troubleshooting

Figure 5-1 contains generator set troubleshooting, diagnostic, and repair information. Check for loose connections before replacing parts.

Problem	Possible Cause	Corrective Action
Controller display backlight is off.	Backlight turns off after about 1 minute with no activity.	Backlight will turn on when a button is pressed or the generator set starts.
Controller display is off.	Low or no battery voltage.	Check connections. Check generator set battery. See Figure 5-1.
The generator set does not crank.	Battery weak or dead.	Recharge or replace the battery.
	Battery connections reversed or poor.	Check the connections.
	Fault shutdown.	Check the controller display for fault messages. See Section 2.5. Correct the fault condition and reset the controller.
	Generator set in the OFF mode.	Press the RUN button to start the engine or press AUTO to allow remote starting.
	Generator thermostat tripped.	For trips other than temperature (nuisance trips), reset the thermostat. See Section 2.6.
The generator set cranks but does not start, starts hard, lacks power, or operates erratically.	Air cleaner clogged.	Clean and/or replace the air cleaner.
	Battery weak or dead.	Recharge or replace the battery.
	Battery connection poor.	Clean and tighten the battery connections.
	Spark plug wire connection loose.	Check the spark plug wires.
	Low oil pressure shutdown.	Check for oil leaks. Check the oil level and add oil if necessary.
	Fuel pressure insufficient.	Check the fuel supply and valves.
	Engine malfunction.	Contact an authorized Kohler distributor/dealer.
	Generator thermostat tripped.	For trips other than temperature (nuisance trips), reset the thermostat. See Section 2.6.
No AC output.	Line circuit breaker in the OFF position.	Place the circuit breaker in the ON position.
	Line circuit breaker tripping because of overload.	Reduce the load on the generator set.
	Line circuit breaker tripping because of short circuit.	Contact an authorized Kohler distributor/dealer for service.
	Auxiliary winding circuit breaker tripped.	Reset the circuit breaker (located in junction box). Contact an authorized Kohler distributor/dealer for service if breaker trips repeatedly.
Low output or excessive drop in voltage.	Generator set overloaded.	Reduce the load.
Generator set stops suddenly.	Low oil pressure shutdown.	Check for oil leaks. Check the oil level and add oil if necessary.
	Out of fuel.	Check fuel supply.
	Overcrank shutdown.	Reset the controller. If the overcrank fault occurs again, contact an authorized Kohler distributor/dealer.
	Auxiliary winding circuit breaker tripped.	Reset the circuit breaker (located in junction box.) Contact an authorized Kohler distributor/dealer for service if breaker trips repeatedly.
	Fault shutdown.	Check the controller display for fault messages. See Section 2.5. Correct the fault condition and reset the controller.
	Generator set in the OFF mode.	Press the RUN button to start the engine or press AUTO to allow remote starting.
	Remote stop command received from a remote switch, ATS, or OnCue® Plus.	Check the remote switch position. Check OnCue Plus.
	Engine malfunction.	Contact an authorized Kohler distributor/dealer.

**Figure 5-1** General Troubleshooting Chart

# Appendix A Abbreviations

The following list contains abbreviations that may appear in this publication.

A, amp	ampere	cfm	cubic feet per minute	exh.	exhaust
ABDC	after bottom dead center	CG	center of gravity	ext.	external
AC	alternating current	CID	cubic inch displacement	F	Fahrenheit, female
A/D	analog to digital	CL	centerline	FHM	flat head machine (screw)
ADC	advanced digital control; analog to digital converter	cm	centimeter	fl. oz.	fluid ounce
adj.	adjust, adjustment	CMOS	complementary metal oxide substrate (semiconductor)	flex.	flexible
ADV	advertising dimensional drawing	com	communications (port)	freq.	frequency
Ah	amp-hour	coml	commercial	FS	full scale
AHWT	anticipatory high water temperature	Coml/Rec	Commercial/Recreational connection	ft.	foot, feet
AISI	American Iron and Steel Institute	conn.	connection	ft. lb.	foot pounds (torque)
ALOP	anticipatory low oil pressure	cont.	continued	ft./min.	feet per minute
alt.	alternator	CPVC	chlorinated polyvinyl chloride	ftp	file transfer protocol
Al	aluminum	crit.	critical	g	gram
ANSI	American National Standards Institute (formerly American Standards Association, ASA)	CSA	Canadian Standards Association	ga.	gauge (meters, wire size)
AO	anticipatory only	CT	current transformer	gal.	gallon
APDC	Air Pollution Control District	Cu	copper	gen.	generator
API	American Petroleum Institute	cUL	Canadian Underwriter's Laboratories	genset	generator set
approx.	approximate, approximately	CUL	Canadian Underwriter's Laboratories	GFI	ground fault interrupter
APU	Auxiliary Power Unit	cu. in.	cubic inch	GND, ⊕	ground
AQMD	Air Quality Management District	cw.	clockwise	gov.	governor
AR	as required, as requested	CWC	city water-cooled	gph	gallons per hour
AS	as supplied, as stated, as suggested	cyl.	cylinder	gpm	gallons per minute
ASE	American Society of Engineers	D/A	digital to analog	gr.	grade, gross
ASME	American Society of Mechanical Engineers	DAC	digital to analog converter	GRD	equipment ground
assy.	assembly	dB	decibel	gr. wt.	gross weight
ASTM	American Society for Testing Materials	dB(A)	decibel (A weighted)	H x W x D	height by width by depth
ATDC	after top dead center	DC	direct current	HC	hex cap
ATS	automatic transfer switch	DCR	direct current resistance	HCHT	high cylinder head temperature
auto.	automatic	deg., °	degree	HD	heavy duty
aux.	auxiliary	dept.	department	HET	high exhaust temp., high engine temp.
avg.	average	dia.	diameter	hex	hexagon
AVR	automatic voltage regulator	DI/EO	dual inlet/end outlet	Hg	mercury (element)
AWG	American Wire Gauge	DIN	Deutsches Institut für Normung e. V. (also Deutsche Industrie Normenausschuss)	HH	hex head
AWM	appliance wiring material	DIP	dual inline package	HHC	hex head cap
bat.	battery	DPDT	double-pole, double-throw	HP	horsepower
BBDC	before bottom dead center	DPST	double-pole, single-throw	hr.	hour
BC	battery charger, battery charging	DS	disconnect switch	HS	heat shrink
BCA	battery charging alternator	DVR	digital voltage regulator	hsg.	housing
BCI	Battery Council International	E <sup>2</sup> PROM, EEPROM	electrically-erasable programmable read-only memory	HVAC	heating, ventilation, and air conditioning
BDC	before dead center	E, emer.	emergency (power source)	HWT	high water temperature
BHP	brake horsepower	ECM	electronic control module, engine control module	Hz	hertz (cycles per second)
blk.	black (paint color), block (engine)	EDI	electronic data interchange	IBC	International Building Code
blk. htr.	block heater	EFR	emergency frequency relay	IC	integrated circuit
BMEP	brake mean effective pressure	e.g.	for example ( <i>exempli gratia</i> )	ID	inside diameter, identification
bps	bits per second	EG	electronic governor	IEC	International Electrotechnical Commission
br.	brass	EGSA	Electrical Generating Systems Association	IEEE	Institute of Electrical and Electronics Engineers
BTDC	before top dead center	EIA	Electronic Industries Association	IMS	improved motor starting
Btu	British thermal unit	EI/EO	end inlet/end outlet	in.	inch
Btu/min.	British thermal units per minute	EMI	electromagnetic interference	in. H <sub>2</sub> O	inches of water
C	Celsius, centigrade	emiss.	emission	in. Hg	inches of mercury
cal.	calorie	eng.	engine	in. lb.	inch pounds
CAN	controller area network	EPA	Environmental Protection Agency	Inc.	incorporated
CARB	California Air Resources Board	EPS	emergency power system	ind.	industrial
CAT5	Category 5 (network cable)	ER	emergency relay	int.	internal
CB	circuit breaker	ES	engineering special, engineered special	int./ext.	internal/external
CC	crank cycle	ESD	electrostatic discharge	I/O	input/output
cc	cubic centimeter	est.	estimated	IP	internet protocol
CCA	cold cranking amps	E-Stop	emergency stop	ISO	International Organization for Standardization
ccw.	counterclockwise	etc.	et cetera (and so forth)	J	joule
CEC	Canadian Electrical Code			JIS	Japanese Industry Standard
cert.	certicate, certification, certified			k	kilo (1000)
cfh	cubic feet per hour			K	kelvin
				kA	kiloampere
				KB	kilobyte (2 <sup>10</sup> bytes)
				KBus	Kohler communication protocol
				kg	kilogram

kg/cm <sup>2</sup>	kilograms per square centimeter	NC	normally closed	RTU	remote terminal unit
kgm	kilogram-meter	NEC	National Electrical Code	RTV	room temperature vulcanization
kg/m <sup>3</sup>	kilograms per cubic meter	NEMA	National Electrical Manufacturers Association	RW	read/write
kHz	kilohertz	NFPA	National Fire Protection Association	SAE	Society of Automotive Engineers
kJ	kilojoule	Nm	newton meter	scfm	standard cubic feet per minute
km	kilometer	NO	normally open	SCR	silicon controlled rectifier
kOhm, kΩ	kilo-ohm	no., nos.	number, numbers	s, sec.	second
kPa	kilopascal	NPS	National Pipe, Straight	SI	<i>Systeme international d'unites</i> , International System of Units
kph	kilometers per hour	NPSC	National Pipe, Straight-coupling	SI/EO	side in/end out
kV	kilovolt	NPT	National Standard taper pipe thread per general use	sil.	silencer
kVA	kilovolt ampere	NPTF	National Pipe, Taper-Fine	SMTP	simple mail transfer protocol
kVAR	kilovolt ampere reactive	NR	not required, normal relay	SN	serial number
kW	kilowatt	ns	nanosecond	SNMP	simple network management protocol
kWh	kilowatt-hour	OC	overcrank	SPDT	single-pole, double-throw
kWm	kilowatt mechanical	OD	outside diameter	SPST	single-pole, single-throw
kWth	kilowatt-thermal	OEM	original equipment manufacturer	spec	specification
L	liter	OF	overfrequency	specs	specification(s)
LAN	local area network	opt.	option, optional	sq.	square
L x W x H	length by width by height	OS	oversize, overspeed	sq. cm	square centimeter
lb.	pound, pounds	OSHA	Occupational Safety and Health Administration	sq. in.	square inch
lbm/ft <sup>3</sup>	pounds mass per cubic feet	OV	overvoltage	SMS	short message service
LCB	line circuit breaker	oz.	ounce	SS	stainless steel
LCD	liquid crystal display	p., pp.	page, pages	std.	standard
LED	light emitting diode	PC	personal computer	stl.	steel
Lph	liters per hour	PCB	printed circuit board	tach.	tachometer
Lpm	liters per minute	pF	picofarad	TB	terminal block
LOP	low oil pressure	PF	power factor	TCP	transmission control protocol
LP	liquefied petroleum	ph., ∅	phase	TD	time delay
LPG	liquefied petroleum gas	PHC	Phillips® head CrimpTite® (screw)	TDC	top dead center
LS	left side	PHH	Phillips® hex head (screw)	TDEC	time delay engine cooldown
L <sub>wa</sub>	sound power level, A weighted	PHM	pan head machine (screw)	TDEN	time delay emergency to normal
LWL	low water level	PLC	programmable logic control	TDES	time delay engine start
LWT	low water temperature	PLC	programmable logic control	TDNE	time delay normal to emergency
m	meter, milli (1/1000)	PMG	permanent magnet generator	TDOE	time delay off to emergency
M	mega (10 <sup>6</sup> when used with SI units), male	pot	potentiometer, potential	TDON	time delay off to normal
m <sup>3</sup>	cubic meter	ppm	parts per million	temp.	temperature
m <sup>3</sup> /hr.	cubic meters per hour	PROM	programmable read-only memory	term.	terminal
m <sup>3</sup> /min.	cubic meters per minute	psi	pounds per square inch	THD	total harmonic distortion
mA	milliampere	psig	pounds per square inch gauge	TIF	telephone influence factor
man.	manual	pt.	pint	tol.	tolerance
max.	maximum	PTC	positive temperature coefficient	turbo.	turbocharger
MB	megabyte (2 <sup>20</sup> bytes)	PTO	power takeoff	typ.	typical (same in multiple locations)
MCCB	molded-case circuit breaker	PVC	polyvinyl chloride	UF	underfrequency
MCM	one thousand circular mils	qt.	quart, quarts	UHF	ultrahigh frequency
megggar	megohmmeter	qty.	quantity	UIF	user interface
MHz	megahertz	R	replacement (emergency)	UL	Underwriter's Laboratories, Inc.
mi.	mile	rad.	radiator, radius	UNC	unified coarse thread (was NC)
mil	one one-thousandth of an inch	RAM	random access memory	UNF	unified fine thread (was NF)
min.	minimum, minute	RBUS	RS-485 proprietary communications	univ.	universal
misc.	miscellaneous	RDO	relay driver output	URL	uniform resource locator (web address)
MJ	megajoule	ref.	reference	US	undersize, underspeed
mJ	millijoule	rem.	remote	UV	ultraviolet, undervoltage
mm	millimeter	Res/Coml	Residential/Commercial	V	volt
mOhm, mΩ	milliohm	RFI	radio frequency interference	VAC	volts alternating current
MOhm, MΩ	megohm	RH	round head	VAR	voltampere reactive
MOV	metal oxide varistor	RHM	round head machine (screw)	VDC	volts direct current
MPa	megapascal	rly.	relay	VFD	vacuum fluorescent display
mpg	miles per gallon	rms	root mean square	VGA	video graphics adapter
mph	miles per hour	rnd.	round	VHF	very high frequency
MS	military standard	RO	read only	W	watt
ms	millisecond	ROM	read only memory	WCR	withstand and closing rating
m/sec.	meters per second	rot.	rotate, rotating	w/	with
mtg.	mounting	rpm	revolutions per minute	WO	write only
MTU	Motoren-und Turbinen-Union	RS	right side	w/o	without
MW	megawatt	RTDs	Resistance Temperature Detectors	wt.	weight
mW	milliwatt			xfrm	transformer
μF	microfarad				
N, norm.	normal (power source)				
NA	not available, not applicable				
nat. gas	natural gas				
NBS	National Bureau of Standards				

# Appendix B DC2 Controller Operation

**Note:** Models 8RESVL, 10RESVL, and 12RESVL built before 2019 are equipped with the DC2 controller.

## DC2 Generator Set/ Transfer Switch Controller

The DC2 controls the following power system components:

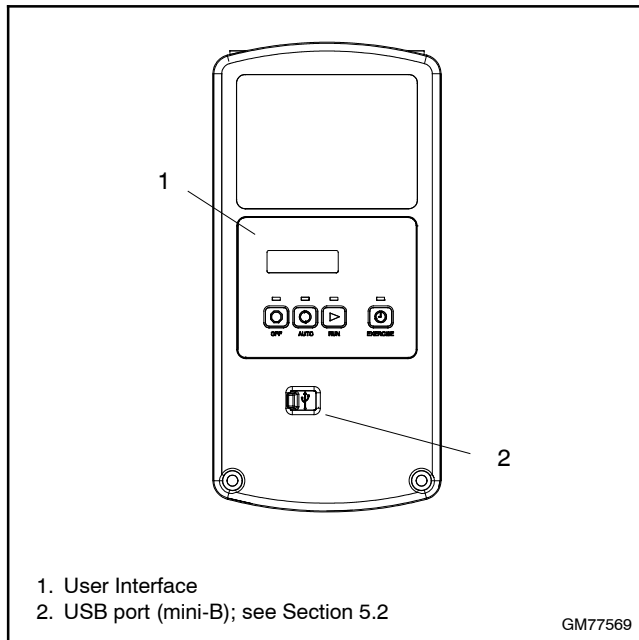
- Model 8RESVL, 10RESVL, or 12RESVL generator set
- Model RXT Automatic Transfer Switch (ATS)
- Programmable Interface Module (PIM)

DC2 controller features include:

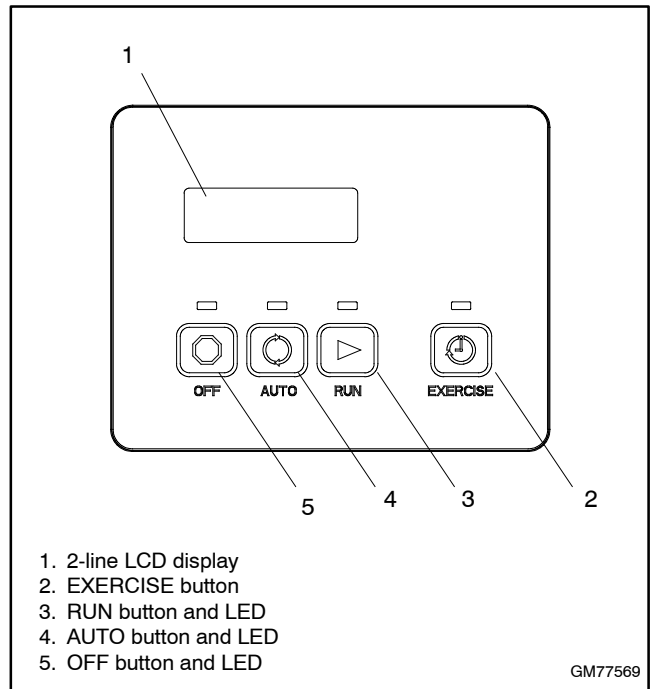
- Two-line x 16 character backlit digital display with adjustable contrast
- OFF, AUTO, RUN, and EXERCISE generator set control buttons

## Controls and Indicators

Figure 5-2 illustrates the DC2 controller. See Figure 5-3 for details of the controller's user interface.



**Figure 5-2** DC2 Controls and Indicators



**Figure 5-3** DC2 User Interface

# Controller Keypad

## Control Buttons

The RUN, OFF, and AUTO buttons control the generator set as described in Figure 5-4.

Use the EXERCISE button to set the exerciser on the DC2 controller.

**Note:** A personal computer (laptop) with Kohler® SiteTech™ software is required for changing settings on the DC2 controller.

Button	Button Function
RUN	Press to start the generator set. The engine start time delay is ignored. The software version and engine model are displayed briefly when RUN is pressed.
OFF	Stops the generator set. The cooldown time delay is ignored. During the engine crank cycle, pressing OFF will stop the crank cycle. Press to clear faults and reset the controller. Press and hold to access the event log.
AUTO	Press to place the generator set in Automatic (standby) mode. Press to exit the event log. Press and hold AUTO and OFF to reset the maintenance timer.
EXERCISE	When the controller is in AUTO mode, press to set the exerciser. When the controller is OFF, press and hold to reset the OnCue password.

**Figure 5-4** DC2 Controller Pushbutton Operation

## LED Indicators

LEDs above the RUN, OFF, and AUTO buttons indicate the mode of operation as shown in Figure 5-5.

LED	LED Indication	Description
RUN	RUN LED is on.	Generator set is running. Remote start and stop commands are ignored.
OFF	OFF LED lights for 2 seconds, then flashes every 2 seconds.	Generator set and controller are off. Remote start/stop commands have no effect. The exercise cycle will not run.
	In Auto mode, OFF LED flashes quickly to indicate a fault shutdown.	Attention required. Identify and correct the fault condition before resetting the controller.
AUTO	AUTO LED is on.	Automatic (standby) mode. Generator set will respond to engine start and stop commands from the controller (for example, exercise start and stop commands) or an ATS. Time delays operate as described in Section 2.3.

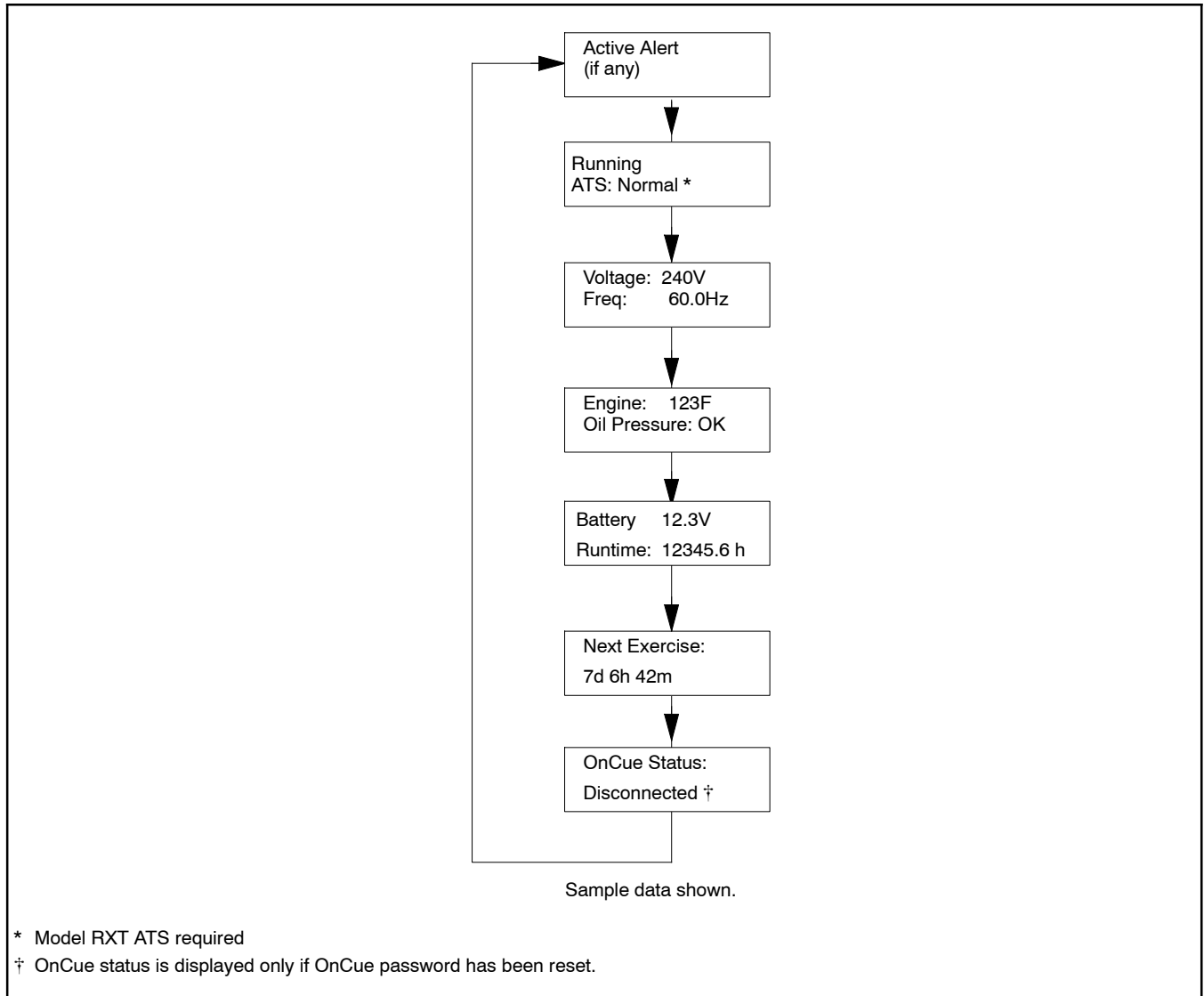
**Figure 5-5** DC2 Controller LED Operation

# LCD Display

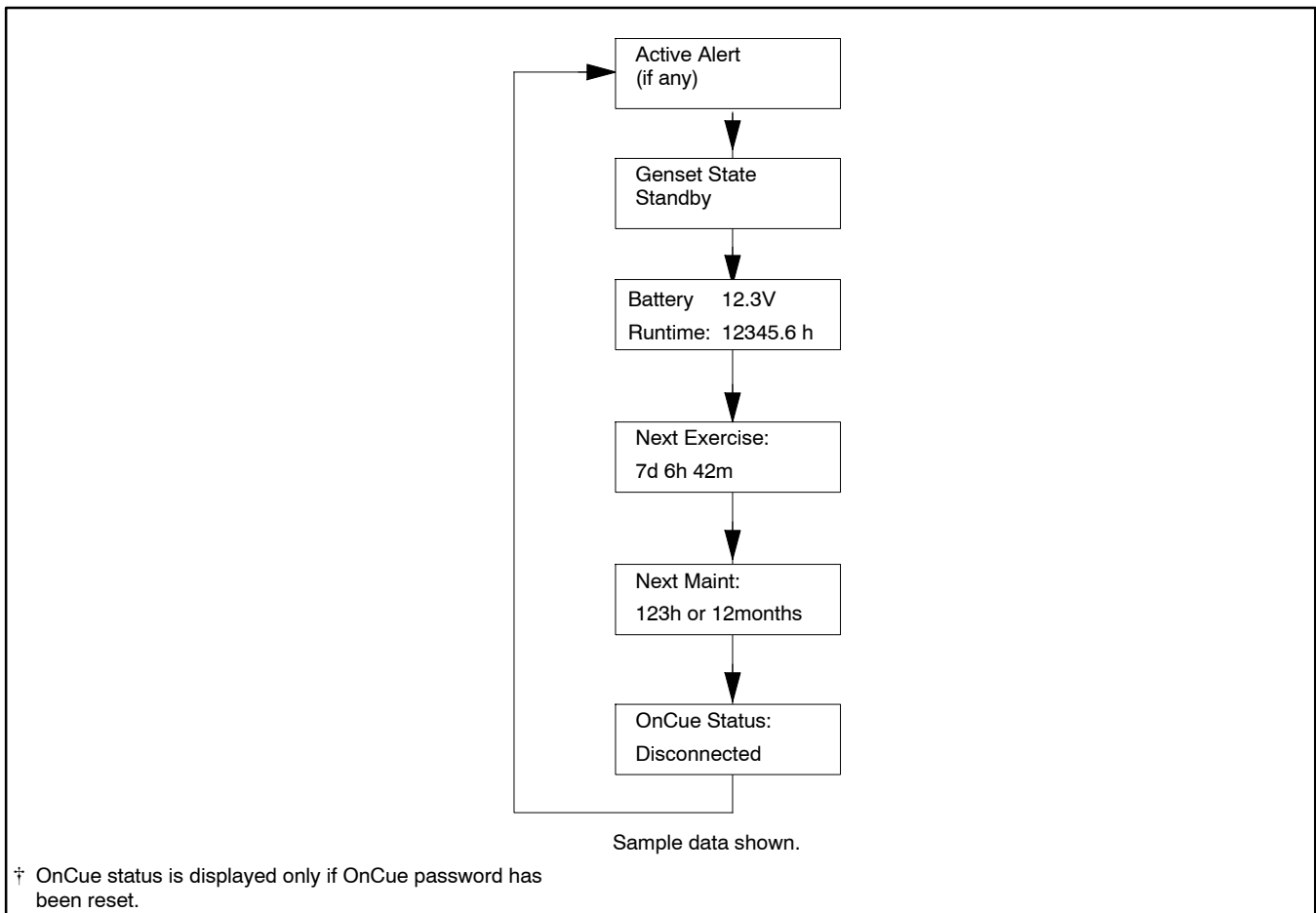
The controller is equipped with a two-line x 16 character backlit digital display with adjustable contrast. When the generator set is running, the messages shown in Figure 5-6 are displayed. When the system is in AUTO, the LCD display steps through the status messages shown in Figure 5-7.

When a fault or warning condition exists, the controller will show the corresponding message. See Section 2.5 for more information on fault and warning messages.

The display backlight turns off after about a minute of no activity. The backlight turns on when a button is pressed or when the generator set starts.



**Figure 5-6** Status Displays, Generator Running



**Figure 5-7** Status Displays, Generator in Standby

## Controller Power

The DC2 controller is powered by the generator set engine starting battery.

**Note:** To disconnect controller power, disconnect the utility power to the generator set and disconnect the battery (negative lead first).

## Battery Charging

The controller includes a built-in battery charger to maintain the engine starting battery. The DC2 controller monitors the battery voltage and provides a constant  $14 \pm 2\%$  VDC voltage and maximum 2.5 amps to charge the battery.

The installer must connect 120 VAC/60Hz utility power provided from the building on a breaker-protected circuit for the built-in battery charger. See the Installation Manual for instructions to connect power.

## Exercise

The DC2 controller can be set to automatically run the generator set at the same time and day each week. Exercising the generator set weekly is required to keep the engine and alternator in good operating condition.

A laptop computer with Kohler® SiteTech™ software can be used to change the exercise frequency to every two weeks. Use a USB cable to connect the controller to the computer and see TP-6701, SiteTech Operation Manual for instructions.



## Exercise Modes

Unloaded Cycle or Loaded Full-Speed exercises can be set from the DC2 controller. The Unloaded Cycle exercise mode is the default exercise mode. A Model RXT transfer switch is required for the Loaded Full-Speed exercise mode. See Section 2.4 for more information about the exercise modes.

A laptop computer with Kohler® SiteTech™ software can be used to change the exercise mode to Unloaded Full Speed.

## Setting the Exerciser

Set the exerciser to automatically run the generator set for 20 minutes every week. Follow the procedure below to set the exerciser.

### Procedure to Set the Exerciser

1. Press AUTO. Verify that the AUTO LED is on and Utility power is available.
2. Press the exercise button to start an unloaded exercise.
3. If a loaded exercise is required, press the Exercise button again within 5 seconds.
4. After 5 seconds, the generator begins its crank cycles. During the crank cycles, the number of the crank cycle is displayed. No button presses are acknowledged during the crank cycles.
5. The generator runs through the exercise cycle described in Section 2.4.2. The controller monitors the system during the unloaded exercise as described in System Diagnostics.
6. After 20 minutes, the engine stops automatically.

The exercise time is set to the time the exercise button is pressed. An unloaded or loaded exercise, as selected above, will occur at the same time every seven days.

## Exerciser Reset

To reset the exerciser to run at a different day and/or time, follow the procedure above to enter the new exerciser settings. The old settings will be replaced by the new time and day.

## Faults

The controller displays fault messages for generator set warnings and shutdowns. Selected fault messages are shown in Figure 2-3.

## Warnings

The controller displays a fault message but the generator set does not shut down on a warning. The controller resets automatically after a warning condition is corrected.

## Shutdowns

Under a fault shutdown condition, the generator set shuts down automatically and the controller displays a fault message. The OFF LED flashes. In some cases, the engine cooldown cycle runs before the engine shuts down. See Figure 2-3.

Shutdown switches (such as the low oil pressure switch or high engine temperature switch) on the generator set will automatically reset when the problem is corrected. However, the fault condition at the controller does not clear until the controller is reset.

The generator set cannot be restarted until the fault condition is corrected and the controller is reset. See Section 2.5.4 for instructions to reset the controller after a fault shutdown.

## ATS Communication Errors

When a Model RXT transfer switch is used, an ATS fault indicates that the connection to the interface board on the transfer switch has been lost. Check the connection to the ATS interface board.

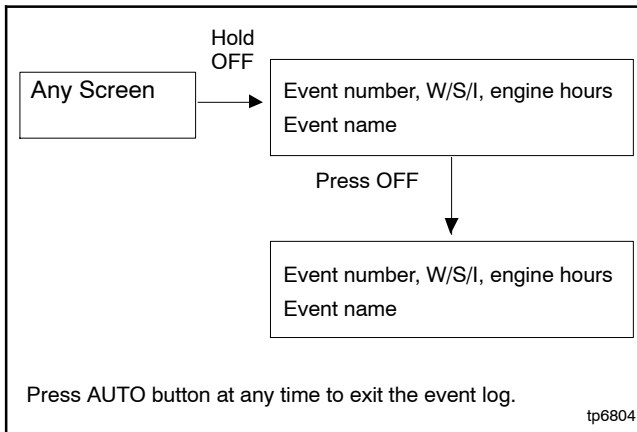
## Resetting the Controller after a Fault Shutdown

Always identify and correct the cause of a fault shutdown before resetting the controller. Check the fault message displayed on the controller and refer to Figure 2-3 to identify and correct the fault condition before proceeding. Contact an authorized distributor/dealer for service, if necessary.

Press the OFF button to clear the fault message on the controller.

## Event Log

The event log displays up to 10 controller faults and notices, starting with the most recent event. Events are numbered 1- 10, with 1 being the most recent. Each event is displayed with the date and time of the event, the number of the event, a letter to indicate whether the event was a warning (W), shutdown (S), or informational notice (I), the engine hours at the time of the event, and the event description. See Figure 5-8.



**Figure 5-8** Event Log

### Procedure to View Event Log

1. Press the OFF button. The controller must be OFF to display the event log.
2. Press and hold the OFF button until the first event appears on the display.
3. Press OFF to step through the other events.
4. To exit the Event Log, hold the OFF button or press the AUTO button.

# Maintenance Timer

The maintenance timer keeps track of the time until the next recommended maintenance according to the maintenance schedule for the generator set. Reset the maintenance timer after changing the oil and performing the other maintenance tasks recommended in Section 4.

To reset the maintenance timer:

1. Press and hold the OFF and AUTO buttons together until Maintenance Timer Reset is displayed.
2. Release the OFF and AUTO buttons.

# OnCue Plus Password

To set the OnCue® Plus password on the DC2 controller,

1. Press the OFF button and verify that the generator set is not running.
2. Press and hold the Exercise button until Press Again to Reset OnCue PW is displayed.
3. Release the Exercise button and press it again within 5 seconds.

**Note:** If the Exercise button is not pressed within 5 seconds, the controller exits the password reset mode.

4. The genset serial number and new password (PW) will be displayed for 10 seconds. Record the password for entry into the OnCue® Plus program.

# Notes

# Notes

# Notes



**TP-6880 12/18d**

© 2014, 2015, 2018 by Kohler Co. All rights reserved.

**KOHLER®**

KOHLER CO., Kohler, Wisconsin 53044  
Phone 920-457-4441, Fax 920-459-1646  
For the nearest sales/service outlet in the  
US and Canada, phone 1-800-544-2444  
[KOHLERPower.com](http://KOHLERPower.com)